

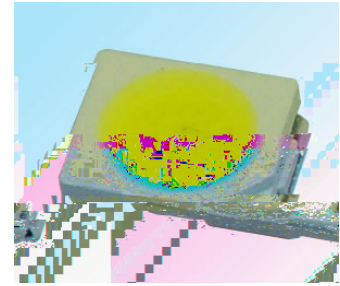

## HL-A-3528H252W-S1-10-HR3

### Features( 特征)

- PLCC-2 Package.(PLCC-2 封装)
- Extremely wide viewing angle. (宽的发光角度)
- Suitable for all SMT assembly and solder process. (适用于所有的SMT组装和焊接工艺)
- Available on tape and reel. (适用于载带及卷轴)
- Moisture sensitivity level: Level 4. (防潮等级 Level 4)
- Package:3000pcs/reel..(包装每卷3000PCS)
- RoHS compliant. (RoHS 认证)



### Description (描述)

The White LED which was fabricated using a blue chip and the phosphor  
白光LED由蓝光芯片与荧光粉激发而成



**ATTENTION**  
OBSERVE PRECAUTIONS  
FOR HANDLING  
ELECTROSTATIC  
DISCHARGE  
SENSITIVE  
DEVICES

注意：操作时应注意静电敏感  
释放设备装置

### Applications (应用)

- Optical indicator (光学指示)
- Indoor display (室内显示)
- Automotive lighting (汽车照明)
- Backlight for LCD, switch and Symbol, display  
(LCD背光、转换器, 开关和标志, 显示器等)
- Tubular light application (用于日光灯管)
- General use (一般应用)

### Package Dimensions (封装尺寸)

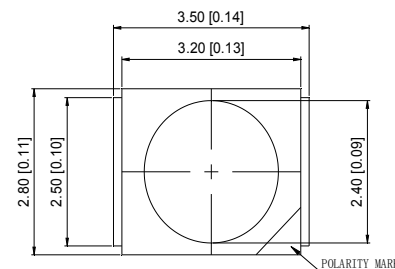

### Recommended Soldering Pattern

(建议焊盘尺寸图)

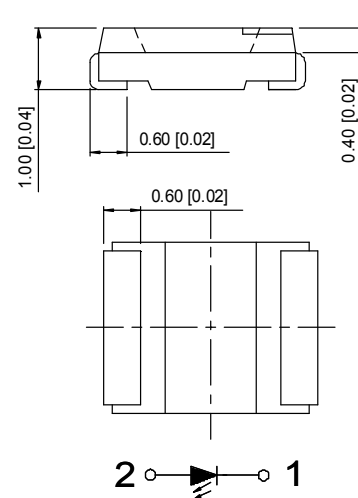
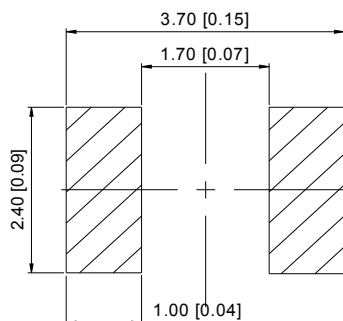

Notes: (备注)

1. All dimension units are millimeters. (所有标注尺寸单位为毫米)
2. All dimension tolerance is  $\pm 0.15\text{mm}$  unless otherwise noted. (除特别标注外, 所有尺寸允许公差 $\pm 0.15\text{mm}$ )

## HL-A-3528H252W-S1-10-HR3

### Selection Guide (选择指南)

Part No. 型号	Chip Materials 芯片材料	Lens Type 胶体类型
HL-A-3528H252W-S1-10-HR3	InGaN	Yellow Diffused

### Mass Production list (批量生产目录)

Part No. 型号	CCT (K) Min	CCT (K) Typ	CCT (K) Max	Φ (lm) Min	Φ (lm) Typ	Test Condi- tions 测试条件
HL-A-3528H252W-S1-10-HR3	5700	6000	6500	8.8	9.3	IF=20mA
	4750	5000	5300	8.8	9.3	IF=20mA
	3800	4000	4250	8.8	9.3	IF=20mA
	2800	3000	3100	8.3	8.8	IF=20mA

### Electrical / Optical Characteristics at Ta=25°C 电性与光学特性

Parameter (参数)	Symbol (符号)	Min. (最小)	Typ. (平均)	Max. (最大)	Units (单位)	Test Conditions 测试条件
Forward Voltage 正向电压	VF	2.6	--	3.3	V	IF=20mA
Viewing Angle 角度	2θ1/2	--	120	--	deg	IF=20mA
Color Rendering Index 显色性指数	Ra	80	--	--		IF=20mA
Reverse Current 反向电流	IR	--	--	10	μA	VR = 5V

#### Note:(备注)

- 2θ1/2 is the angle from optical centerline where the luminous intensity is 1/2 the optical centerline value.  
2θ1/2 是半值角,指光强是光学中心线光强的1/2处到光学中心线的角度
- The above luminous flux measurement allowance tolerance is ±10%.  
上述发光通量的测试允许公差为±10%
- The above Color Rendering Index measurement allowance tolerance is ±2  
以上显色性指数的测试允许公差为±2
- The above forward voltage measurement allowance tolerance is ±0.1V.  
以上所示电压测量误差±0.1V
- The above color coordinates measurement allowance tolerance is ±0.003.  
以上所示坐标测量误差±0.003

## HL-A-3528H252W-S1-10-HR3

### Absolute Maximum Ratings at Ta=25°C 绝对最大额定值

Parameter (参数)	Symbol (符号)	Rating (值)	Units (单位)
Power Dissipation (功耗)	Pd	100	mW
Forward Current (正向电流)	IF	30	mA
Peak Forward Current [1] (峰值正向电流)	IFP	100	mA
Reverse Voltage (反向电压)	VR	5	V
Electrostatic Discharge (HBM) (静电)	ESD	1000	V
Operating Temperature (操作温度)	Topr	-40 ~ +85	°C
Storage Temperature (保存温度)	Tstg	-40 ~ +100	°C
Thermal Resistance (Junction / Soldering point) 热阻	Rthj-s	100	°C/W
Junction Temperature结温	Tj	115	°C

Note: (备注)

1. 1/10 Duty cycle, 0.1ms pulse width. (脉宽0.1ms, 周期1/10)

# HL-A-3528H252W-S1-10-HR3

## Typical optical characteristics curves 典型光学特性曲线

Soldering Temperature vs. Forward Current  
焊盘温度与正向电流特性曲线

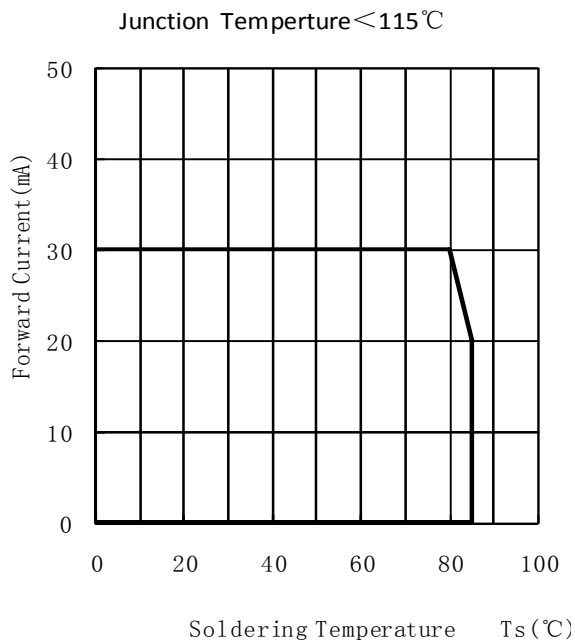

Forward Current VS. Relative Intensity  
正向电流与相对光强特性曲线

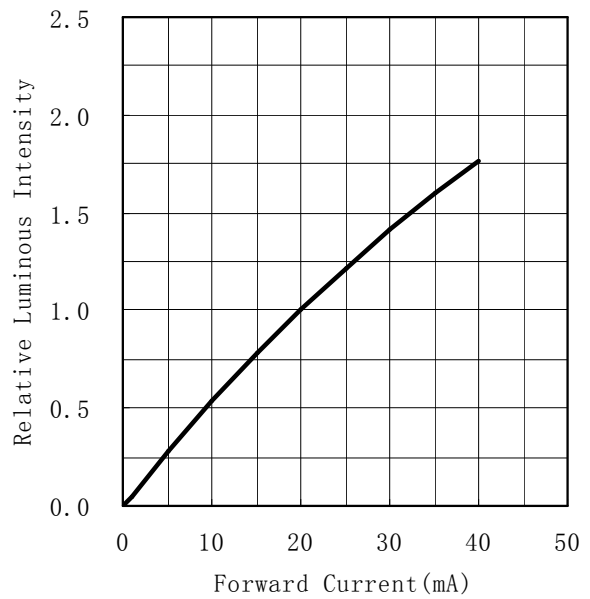

Forward Voltage VS. Forward Current  
正向电压与正向电流特性曲线

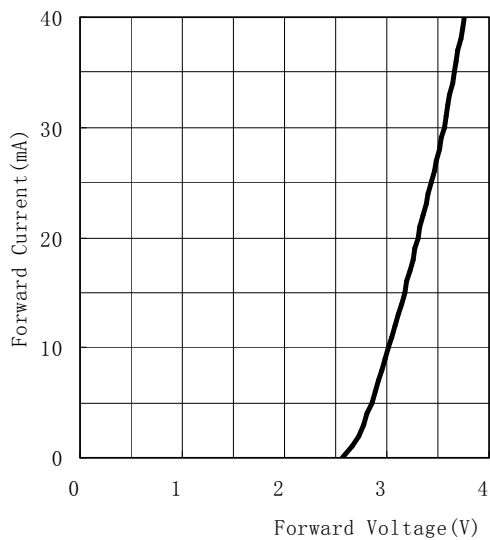

Ambient Temperature VS. Relative Intensity  
环境温度与相对光强特性曲线

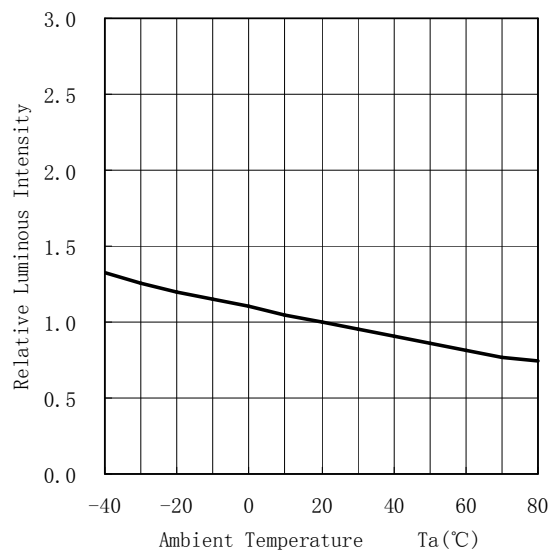

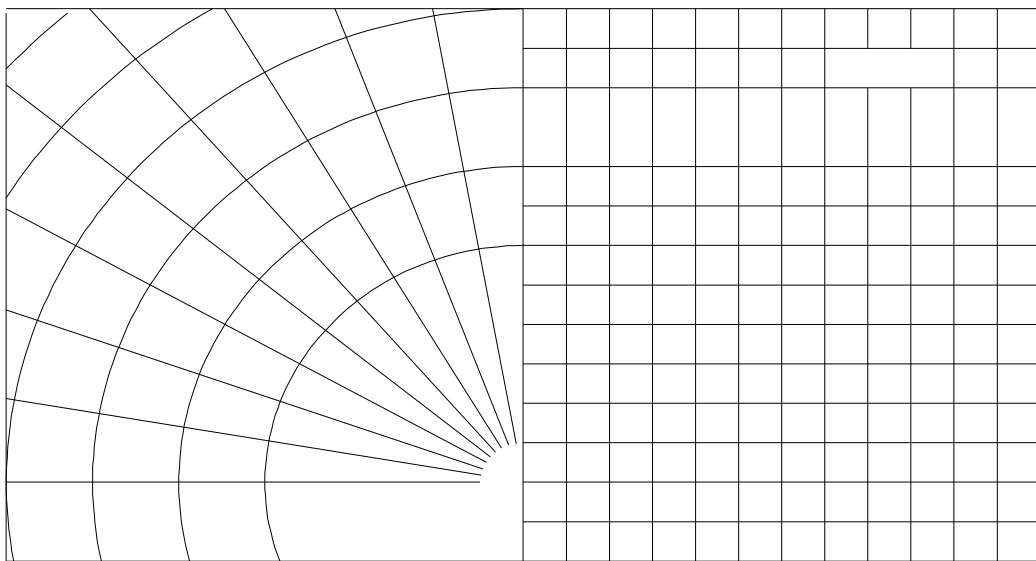

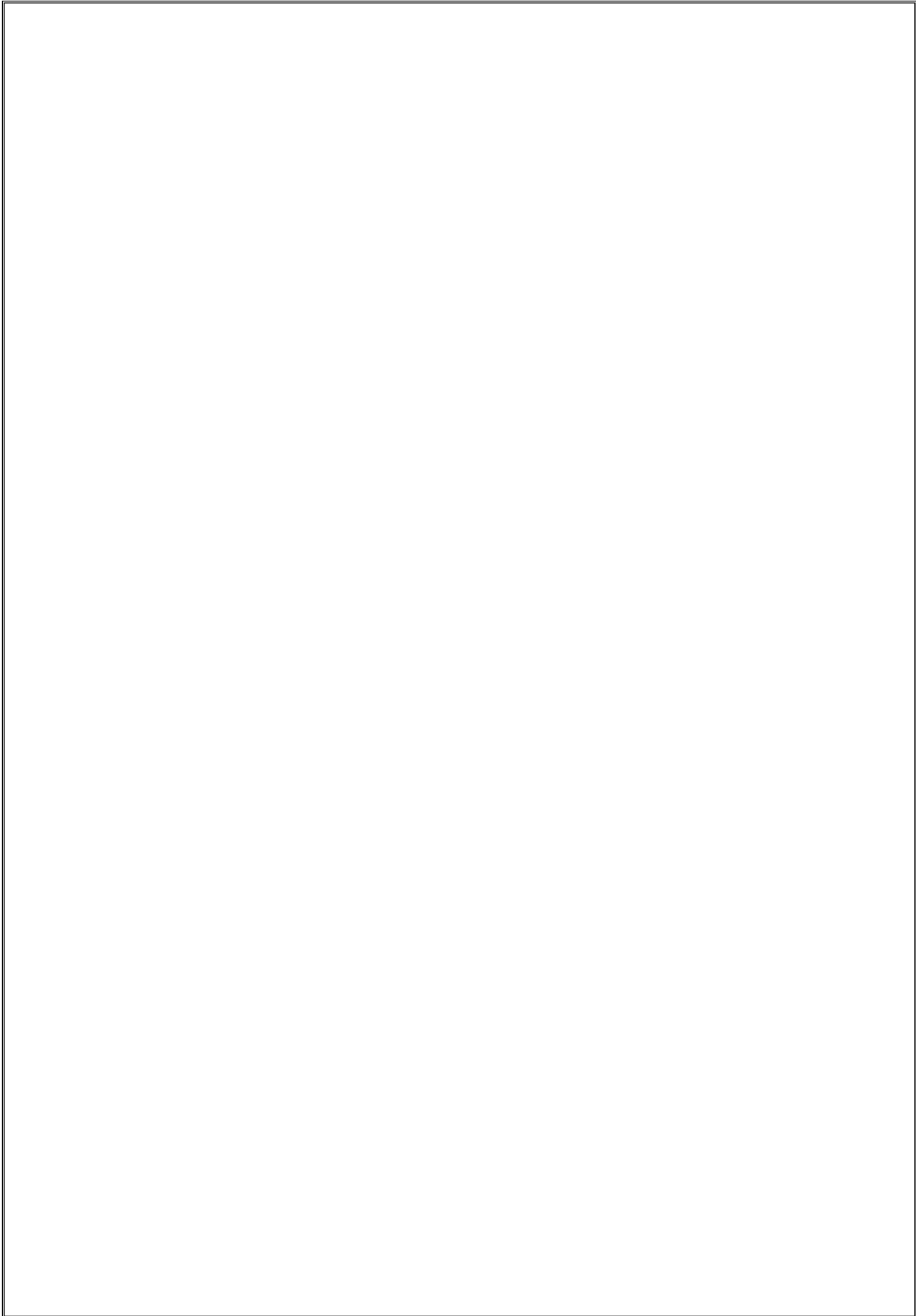

## HL-A-3528H252W-S1-10-HR3

### Bin Range of Chromaticity Coordinate Bin区分类及色坐标范围

CCT 色温	Bin Code Bin代码	CIE_x	CIE_y	Bin Code Bin代码	CIE_x	CIE_y	
6000K	C32 6000-6500K	0.3205	0.3481	C42 5700-6000K	0.3211	0.3468	
		0.3117	0.3393		0.3294	0.3542	
		0.3131	0.329		0.3296	0.3429	
		0.3213	0.3371		0.3219	0.3360	
		0.3213	0.3371		0.3219	0.3360	
	C33 6000-6500K	0.3131	0.329	C43 5700-6000K	0.3296	0.3429	
		0.3145	0.3187		0.3298	0.3315	
		0.3221	0.3261		0.3227	0.3251	
		0.3376	0.3616		0.3461	0.3685	
		0.3461	0.3685		0.3545	0.3754	
5000K	C62 5000-5300K	0.3451	0.3561	N12 4750-5000K	0.3530	0.3625	
		0.3372	0.3497		0.3451	0.3561	
		0.3372	0.3497		0.3451	0.3561	
		0.3451	0.3561		0.3530	0.3625	
		0.3441	0.3437		0.3514	0.3496	
	C63 5000-5300K	0.3368	0.3378	N13 4750-5000K	0.3441	0.3437	
		0.3731	0.3853		N52 3800-4000K	0.3839	0.3920
		0.3839	0.3920			0.3947	0.3987
		0.3803	0.3777			0.3903	0.3839
		0.3703	0.3716			0.3803	0.3777
0.3703	0.3716	0.3803	0.3777				
4000K	N42 4000-4250K	0.3803	0.3777	N53 3800-4000K	0.3903	0.3839	
		0.3767	0.3634		0.3858	0.3690	
		0.3675	0.3578		0.3767	0.3634	



## HL-A-3528H252W-S1-10-HR3

### Bin Range of Chromaticity Coordinate Bin区分类及色坐标范围

CCT 色温	Bin Code Bin代码	CIE_x	CIE_y	Bin Code Bin代码	CIE_x	CIE_y
3000K	W42 3000-3100K	0.4354	0.4142	W43 3000-3100K	0.4316	0.4059
		0.4430	0.4165		0.4390	0.4082
		0.4390	0.4082		0.4350	0.3998
		0.4316	0.4059		0.4279	0.3975
		0.4279	0.3975		0.4430	0.4165
		0.4350	0.3998		0.4505	0.4189
	W44 3000-3100K	0.4310	0.3915	W52 2900-3000K	0.4463	0.4106
		0.4241	0.3892		0.4390	0.4082
		0.4390	0.4082		0.4350	0.3998
		0.4463	0.4106		0.4420	0.4022
		0.4420	0.4022		0.4378	0.3939
		0.4350	0.3998		0.4310	0.3915
	W62 2800-2900K	0.4505	0.4189	W63 2800-2900K	0.4463	0.4106
		0.4581	0.4212		0.4536	0.4129
		0.4536	0.4129		0.4492	0.4045
		0.4463	0.4106		0.4420	0.4022
		0.4420	0.4022			
		0.4492	0.4045			
	W64 2800-2900K	0.4447	0.3962			
		0.4378	0.3939			

**Reliability Test Items And Conditions 信赖性测试项目及条件**

Test Items 项目	Ref. Standard 参考标准	Test Condition 测试条件	Time 时间	Quantity 数量	Ac/Re 接收/拒收
Reflow 回流焊	JESD22-B106	Temp:260°Cmax T=10 sec	3 times.	22Pcs.	0/1
Temperature Cycle 温度循环	JESD22-A104	100°C±5°C 30 min. ↑↓5 min -40°C±5°C 30 min.	100 Cycles	22Pcs.	0/1
High Temperature Storage 高温保存	JESD22-A103	Temp:100°C±5°C	1000Hrs.	22Pcs.	0/1
Low Temperature Storage 低温保存	JESD22-A119	Temp:-40°C±5°C	1000Hrs.	22Pcs.	0/1
Life Test 常温通电	JESD22-A108	Ta=25°C±5°C IF=20mA	1000Hrs.	22Pcs.	0/1
High Temperature High Humidity Life Test 高温高湿通电	JESD22-A101	85°C±5°C/ 85%RH IF=20mA	1000Hrs.	22Pcs.	0/1

 Symbol  
 符号

 Test Condition  
 测试条件

 Failure Criteria  
 判定标准  
 条件 封  
 0  
 Min. 最小

\*The technical information shown in the data sheets are limited to the typical characteristics and circuit examples of the referenced products. It does not constitute the warranting of industrial property nor the granting of any license.

数据工作表中所示的技术信息仅限于典型特征和电路实例引用的产品。它既不构成工业特性的保证，也不构成任何许可的授权



1. Handle the component along the side surface by using forceps or appropriate tools; do not directly touch or Handle the silicone lens surface, it may damage the internal circuitry.

通过使用适当的工具从材料侧面夹取，不可直接用手或尖锐金属压胶体表面，它可能会损坏内部电路

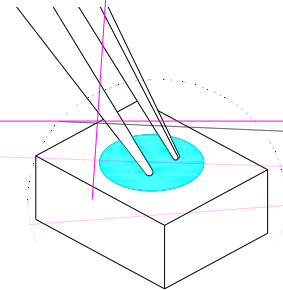
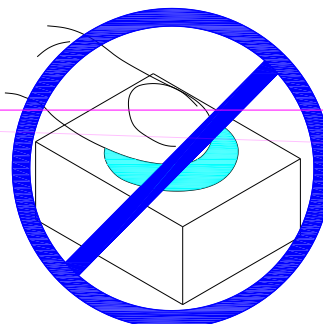
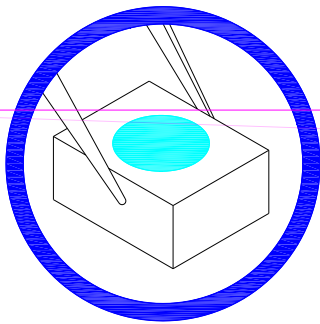

**5.LED operating environment and sulfur element composition cannot be over 100PPM in the LED mating usage material.**

LED工作环境及与LED适配的材料中硫元素及化合物成份不可超过100PPM

**6.When we need to use external glue for LED application products, please make sure that the external glue matches the LED packaging glue. Additionally ,as most of LED packaging glue is silica gel, and it has strong Oxygen permeability as well as strong moisture permeability; in order to prevent external material from getting into the inside of LED, which may cause the malfunction of LED, the single content of Bromine element is required to be less than 900PPM,the single content of Chlorine element is required to be less than 900PPM,the total content of Bromine element and Chlorine element in the external glue of the application products is required to be less than 1500PPM**

当我们需要使用外封胶涂抹LED产品时，应确保外封胶与LED封装胶水相匹配，因为大多数LED的封装胶水为硅胶，它有较强的氧化性和较强的吸湿性，必须防止外封材质进入LED内部以造成LED的损伤，单一的溴元素含量要求小于900PPM，单一氯元素含量要求小于900PPM，在涂抹LED产品时要求外封胶溴元素与氯元素总含量必须小于1500PPM

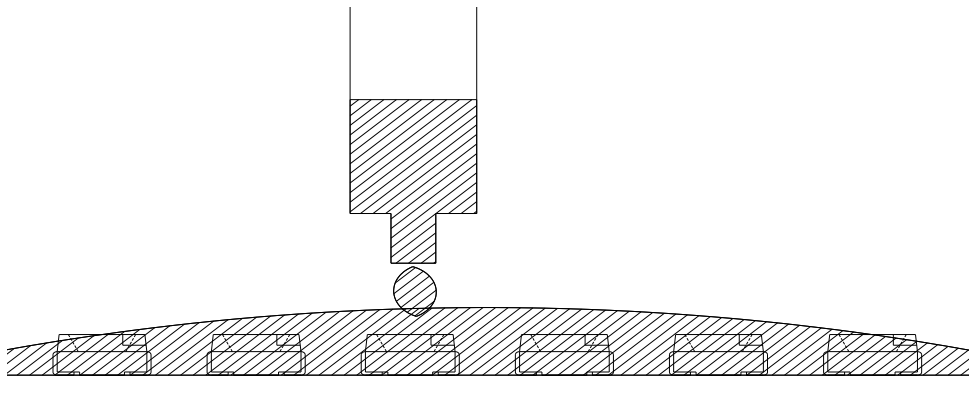

**7.Other points for attention, please refer to our LED user manual.**

其它注意事项请参照我们的LED使用手册

