



			
		<i>Handwritten signature</i>	

.

.

.

.

/



ATTENTION
OBSERVE PRECAUTIONS
FOR HANDLING
ELECTROSTATIC
DISCHARGE
SENSITIVE
DEVICES



-
-
-
-
-

)便携式照明

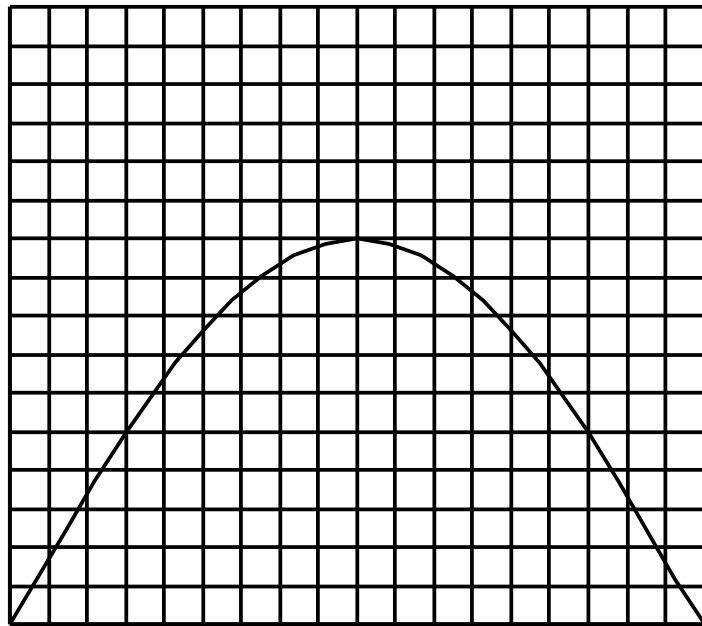
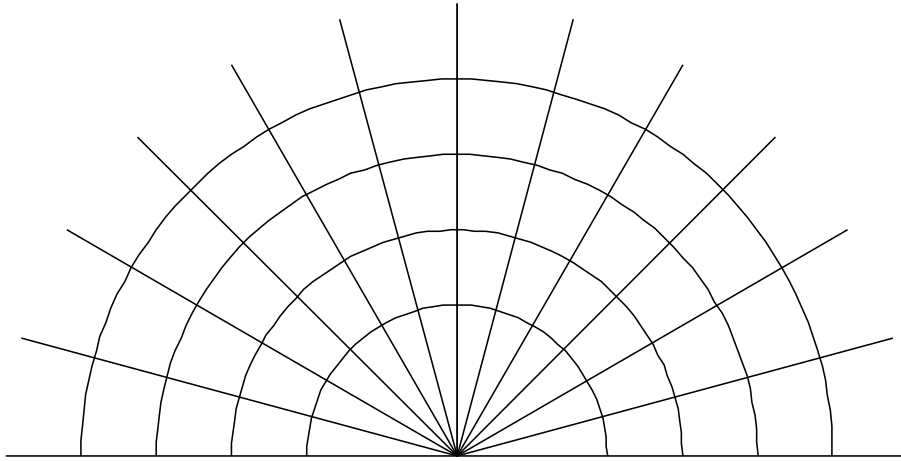

			°
			degrees
		°	°

:

°C,

:



Notes

2.

$T_a=25^{\circ}\text{C}$

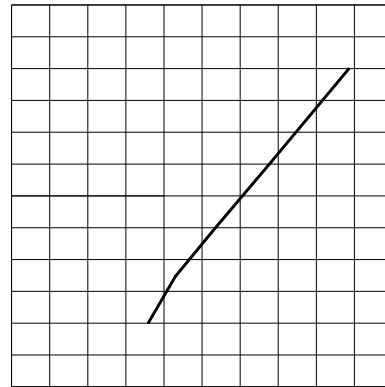
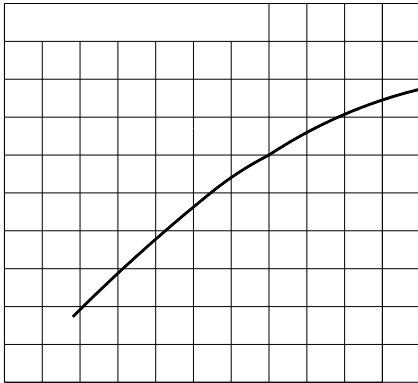

Solder Temperature vs. Relative Luminous Flux

IF=350mA

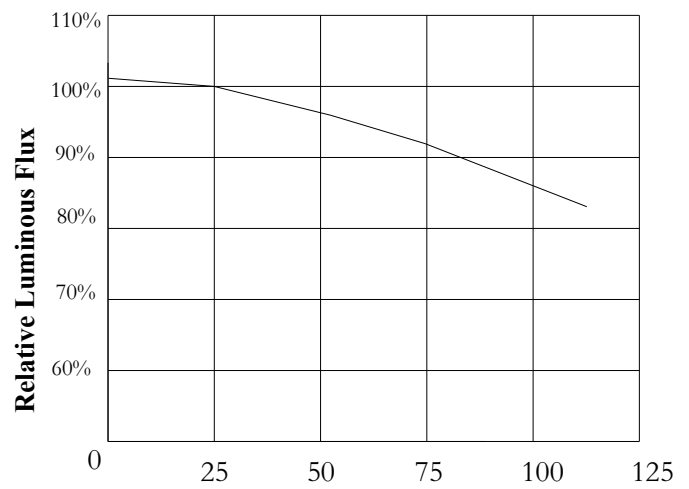
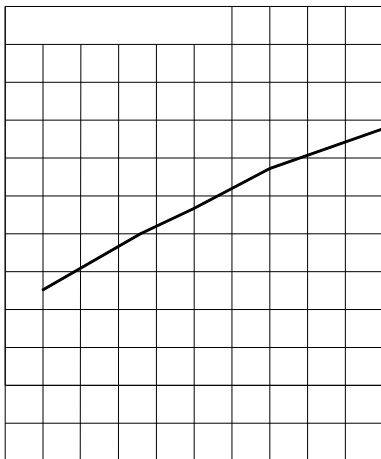

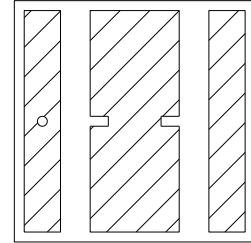
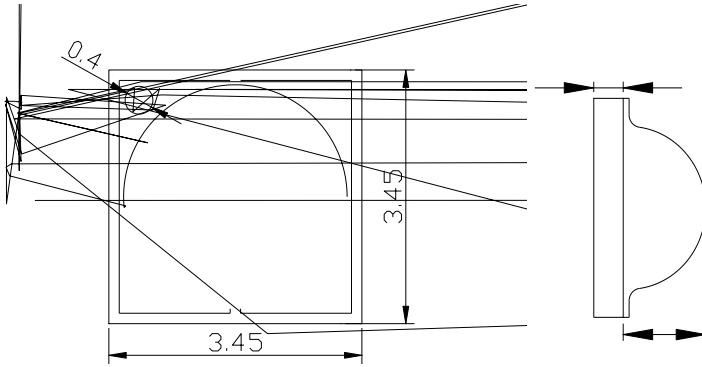

±

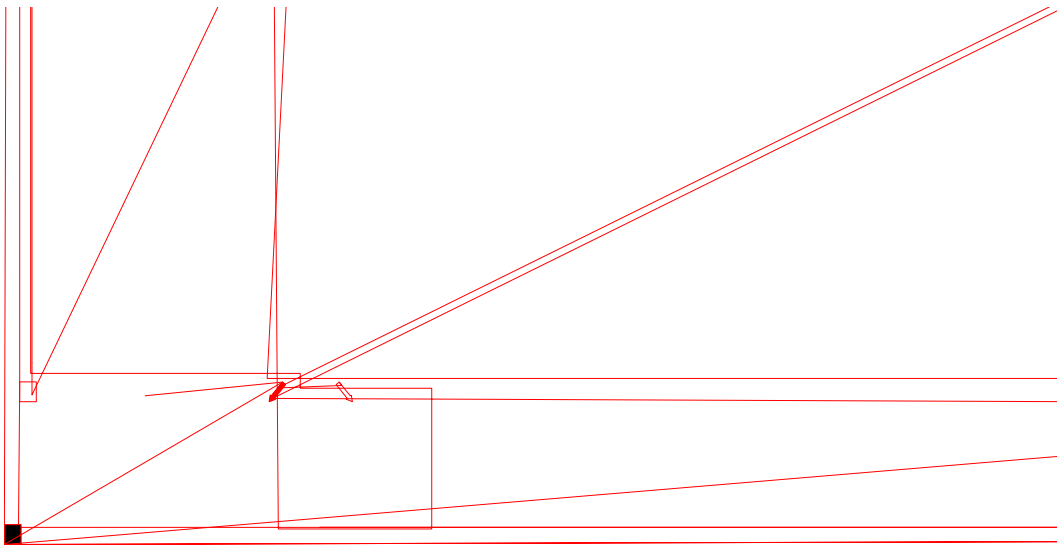

Φ



HONGLITRONIC
鸿利光电

RoHS

TYPE:

QTY:

VF:

XY:

ΦV:

IF:

TC:

DATE:

LOT.NO:

(1) Reel package (1000 pcs/reel)

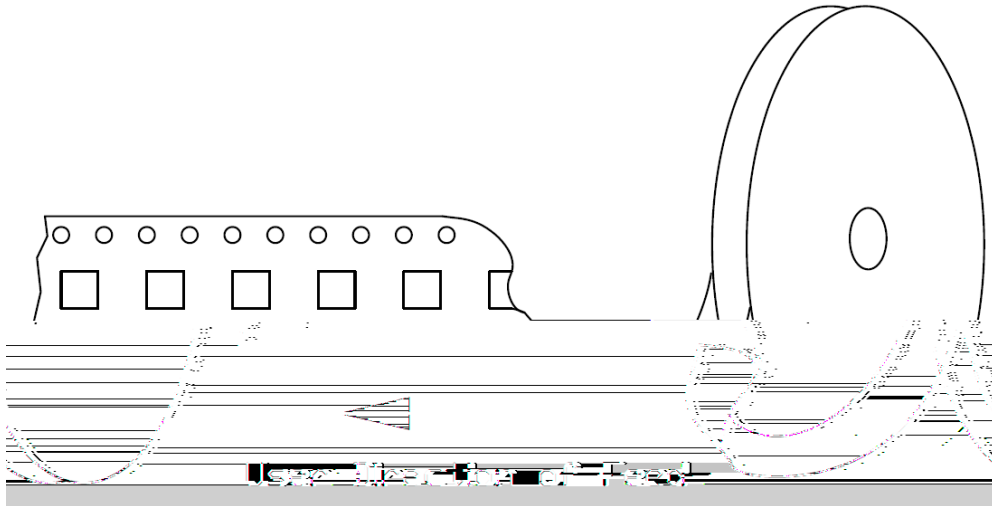
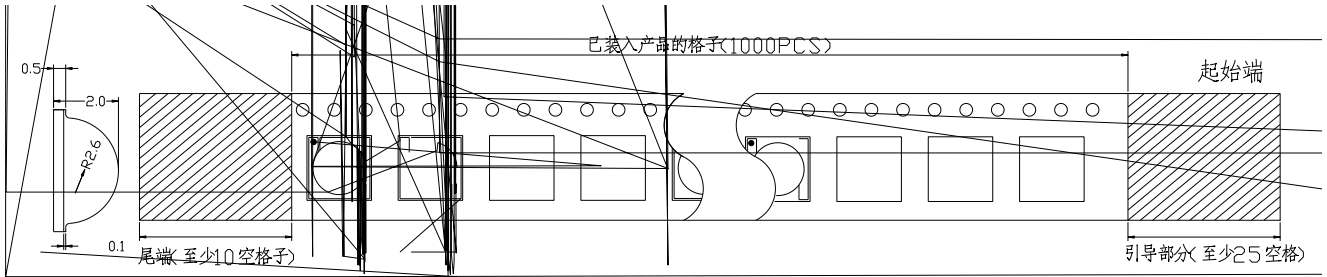

(2) Moisture resistant packaging

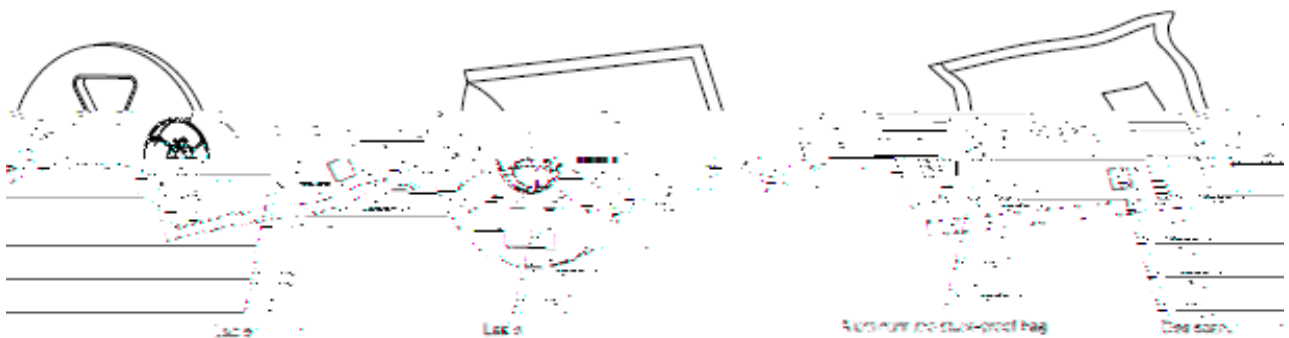

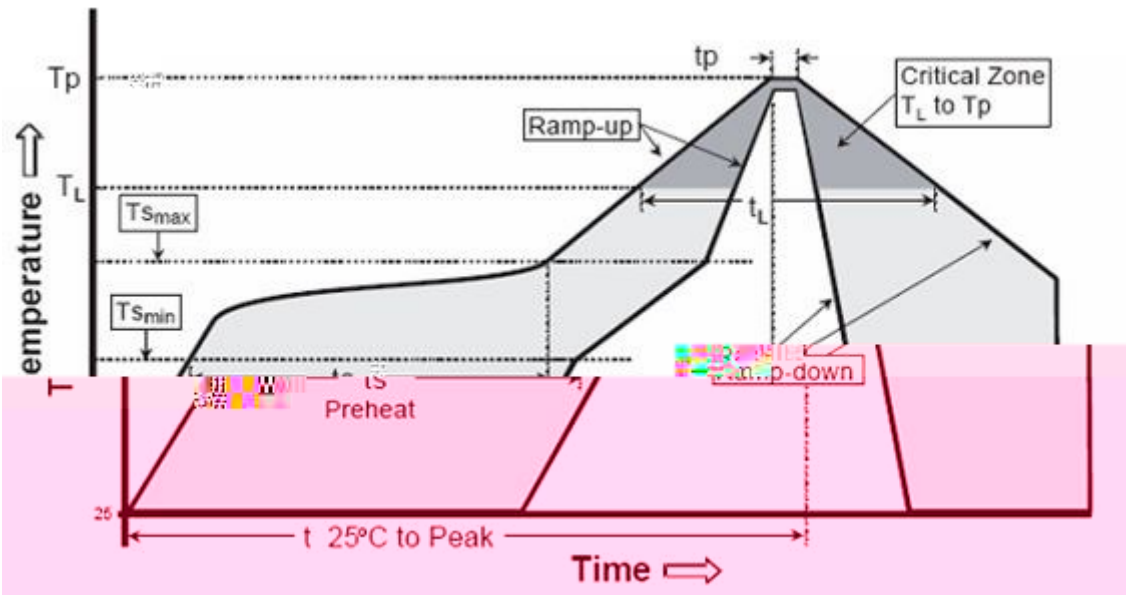

Note:

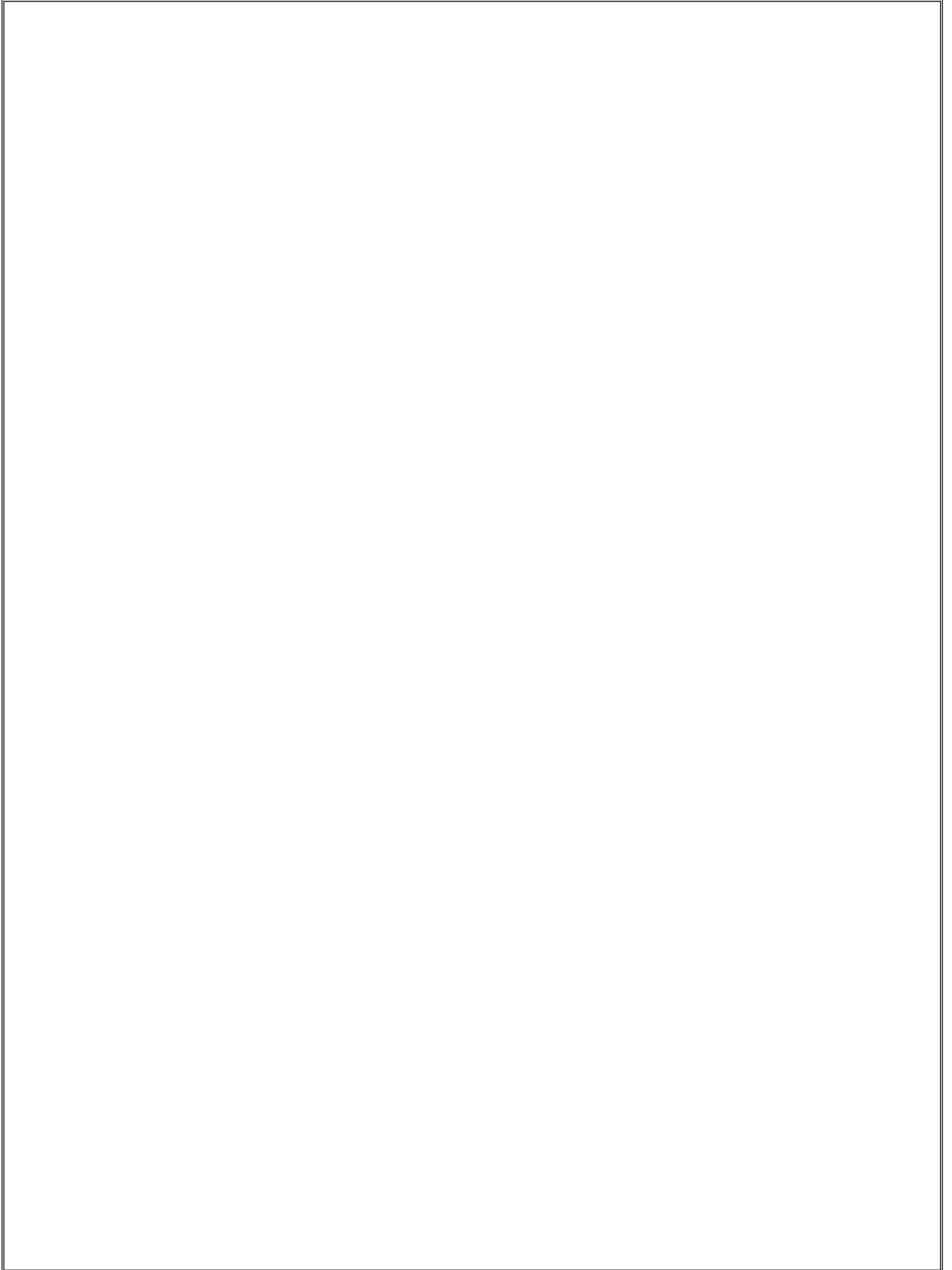

(

(

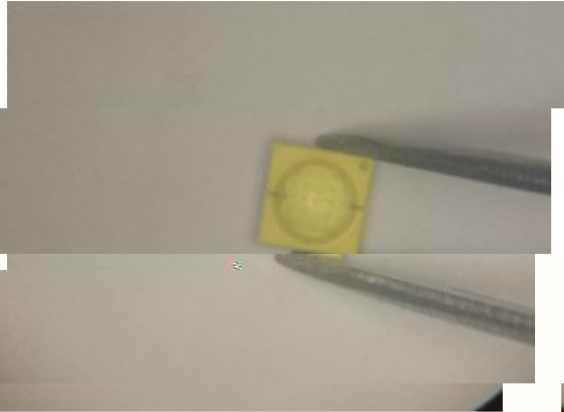

OK

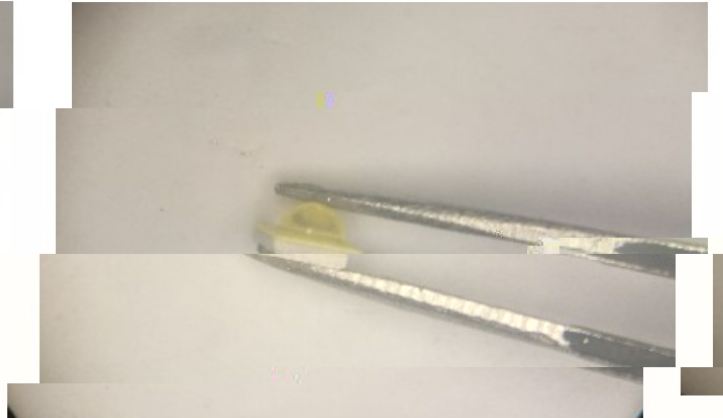

NG

