



TEST REPORT

According to ANSI/IES LM-80-15

-AF-5060H324BS5FS10GC-
[Redacted]

Report Type: 6000 Hours Test Report		Product Type: LED Package	
Reviewed By:	Pote Wang		
Report Number:	SZ2230424-21879E-EE-6000		
Test Date:	2023-04-26 to 2024-01-25		

Report Date:

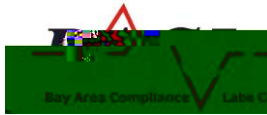
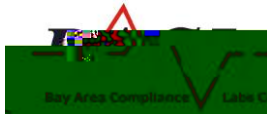

TABLE OF CONTENTS

1 - General Information	3
1.1 Description of LED Light Sources	3
1.2 Standards and Reference Documentations	4
1.3 Testing Equipment	5
1.4 Drive Level	5
1.5 Ambient Conditions for Maintenance Test	5
1.6 Photometric Measurement Method and Uncertainty.....	5
1.7 Statement of Traceability	5
1.8 Sample Set.....	6
2 - Summary of Test Result	8
3 - Test Data	10
3.1 Data Set 1, 55°C, 20mA (Lumen Maintenance)	10
3.2 Data Set 1, 55°C, 20mA (Forward Voltage).....	11
3.3 Data Set 1, 55°C, 20mA (Chromaticity Shift).....	12
3.4 Data Set 2, 85°C, 20mA (Lumen Maintenance)	13
3.5 Data Set 2, 85°C, 20mA (Forward Voltage).....	14
3.6 Data Set 2, 85°C, 20mA (Chromaticity Shift).....	15
3.7 Data Set 3, 55°C, 20mA (Lumen Maintenance)	16
3.8 Data Set 3, 55°C, 20mA (Forward Voltage).....	17
3.9 Data Set 3, 55°C, 20mA (Chromaticity Shift).....	18
3.10 Data Set 4, 85°C, 20mA (Lumen Maintenance)	19
3.11 Data Set 4, 85°C, 20mA (Forward Voltage).....	20
3.12 Data Set 4, 85°C, 20mA (Chromaticity Shift).....	21
3.13 Data Set 5, 55°C, 20mA (Lumen Maintenance)	22
3.14 Data Set 5, 55°C, 20mA (Forward Voltage).....	23
3.15 Data Set 5, 55°C, 20mA (Chromaticity Shift).....	24
3.16 Data Set 6, 85°C, 20mA (Lumen Maintenance)	25
3.17 Data Set 6, 85°C, 20mA (Forward Voltage).....	26
3.18 Data Set 6, 85°C, 20mA (Chromaticity Shift).....	27
4 - DUT Photo	28
4.1 #Mechanical Dimensions.....	28
4.2 DUT Photo.....	28
Directions	30



1 - General Information

1.1 Description of LED Light Sources[#]

Sample Size:

60 PCS test samples were in good condition and received on 2023-04-24. The samples were numbered from 1 to 30 and 31 to 60

Manufacturer:	Hongli Zhihui Group Co.,Ltd. Guangzhou Branch
Part Number:	HL-AF-5060H324BS5FS10GC-S1-PLS-R
Part Type:	LED Package
Drive Level:	DC 20mA
Wavelength:	Red:621nm; Green:522nm; Blue:465nm
Power:	Red:0.04W; Green:0.06W; Blue:0.06W
Average Current Density per LED die:	Red:1063.1mA/mm ² ; Green:775.0mA/mm ² ; Blue:775.0mA/mm ²
Average Power Density per LED die:	Red:2.126W/mm ² ; Green:2.325W/mm ² ; Blue:2.325W/mm ²
CRI:	N/A
Die Spacing:	N/A

Sampling Method:

LED samples for IESNA LM-80 testing consist of units built from a minimum of three manufacturing lots with each manufacturing lot built from different wafer lots built on non-consecutive days.

These manufacturing lots are picked to represent a wide parametric distribution.

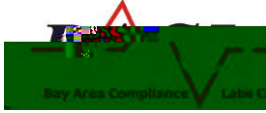

Bay Area Compliance Laboratories Corp. (Dongguan)

No.12, Pulong East 1st Road, Tangxia Town,
Dongguan, Guangdong, China.

Family products covered by this report:

According to *ENERGY STAR® Requirements for the Use of LM-80 Data*, the following products can be covered by this report based on the information and declaration provided by manufacturer. The information of these models shows that the covered products meet all section 4 requirements of *ENERGY STAR® Requirements for the Use of LM-80 Data* (September 28, 2017)

This report covers the following models:

Series Name	Model Name	Total Input Current (mA)	Power (W)	Wavelength (nm)	Number of dies	Driver current per die (mA)	Current Density per Die (mA/mm ²)	Power Density per PCB (W/mm ²)	Die Spacing (mm)
-------------	------------	--------------------------	-----------	-----------------	----------------	-----------------------------	---	--	------------------

0.4

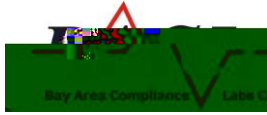

1.3 Testing Equipment

Device	Manufacture	Model No	Serial No	Calibration date	Calibration due date
High Accuracy Array Spectroradiometer	EVERFINE	HAAS 2000	P600674CM5391140	2023-09-02	2024-09-11
0.5M Integrating Sphere	EVERFINE	0.5m	NA	2023-09-02	2024-09-11
LED Test Source	EVERFINE	LTS-300	P185616CJ1391143	2023-09-02	2024-09-11
Standard Light Source	EVERFINE	D062	M133799CM1381112	2023-05-12	2025-05-11
Multilayer aging machine	BACL	B2-270	20013	2023-10-16	2024-10-15
Multilayer aging machine	BACL	B2-270	20023	2023-10-16	2024-10-15
Multilayer aging machine	BACL	B2-384	N/A	2023-10-13	2024-10-12
Digital CC&CV DC Power Supply	EVERFINE	WY5015	11060010	2023-09-02	2024-09-01
Digital CC&CV DC Power Supply	EVERFINE	WY5015	11090008	2023-09-02	2024-09-01
Digital CC&CV DC Power Supply	EVERFINE	WY5015	11090005	2023-10-16	2024-10-15

1.4 Drive Level

Samples are driven with a constant direct current (DC) during maintenance test, photometric and electrical measurement. The current value was regulated to within $\pm 3\%$ of the specified value of the manufacturer during maintenance test, and was within $\pm 0.5\%$ during photometric and electrical measurement test.

1.5 Ambient Conditions for Maintenance Test

For lumen maintenance test, samples within one data set, were installed on cooling boards in thermal chambers with minimal ambient airflow. The case temperature and ambient temperature was monitored by thermocouples which one was soldered to the P (PI L_{LED}) location, while the other is mounted at a distance of 5 mm above the TMP location.

During life testing, TMP_{LED} of the coldest LEDs were maintained at a temperature that was greater than or equal to 2°C below the corresponding nominal case temperature. Surrounding air was maintained at a temperature that was greater than or equal to 5°C below the corresponding nominal case temperature. Thermocouples were shielded from direct DUT optical radiation and comply with = OPI A / , P - O H .

Samples were connected to DC power supply in series circuits with a constant current. The forward current was regulated to within $\pm 3\%$ of the specified value of the manufacturer.

The relative humidity within chamber was kept less than 65% during test.

For photometry measurement, the ambient temperature during test was set to 25°C \pm 2°C, RH <65%.

1.6 Photometric Measurement Method and Uncertainty

Integrating sphere and spectroradiometer is used to measure luminous flux and chromaticity coordinate u v . 2 measurement was used and sample was driven by DC power supply. The forward current was regulated to within $\pm 0.5\%$ of the nominal value. The test system was calibrated by halogen reference lamp. The ambient temperature during test was set to 25°C \pm 2°C, RH <65%. The temperature measurement point was located in the sphere and the temperature was detected by a temperature probe.

The uncertainty of the light output measurements is U=1.59% (K=2), at the 95% confidence level. The uncertainty of the correlated color temperature measurements is U=21K (K=2), at the 95% confidence level.

The uncertainty of the temperature is U=0.8671°C (K=2), at the 95% confidence level.

1.7 Statement of Traceability

Bay Area Compliance Laboratories Corp. (Dongguan) attested that all calibration has been performed using suitable standards traceable to National Primary Standards and International System of Units (SI).

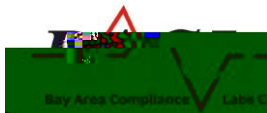

1.8 Sample Set

Data Set 1: 55°C, 20mA(Red)

Part Number: HL-AF-5060H324BS5FS10GC-S1-PLS-R
Number of Units: 30
Case Temperature: >53°C
Ambient Temperature: >50°C
Life Test Drive Current: 20mA
Measurement Current: 20mA

Data Set 2: 85°C, 20mA(Red)

Part Number: HL-AF-5060H324BS5FS10GC-S1-PLS-R
Number of Units: 30
Case Temperature: >83°C
Ambient Temperature: >80°C
Life Test Drive Current: 20mA
Measurement Current: 20mA

Data Set 3: 55°C, 20mA(Green)

Part Number: HL-AF-5060H324BS5FS10GC-S1-PLS-R
Number of Units: 30
Case Temperature: >53°C
Ambient Temperature: >50°C
Life Test Drive Current: 20mA
Measurement Current: 20mA

Data Set 4: 85°C, 20mA(Green)

Part Number: HL-AF-5060H324BS5FS10GC-S1-PLS-R
Number of Units: 30
Case Temperature: >83°C
Ambient Temperature: >80°C
Life Test Drive Current: 20mA
Measurement Current: 20mA

Data Set 5: 55°C, 20mA(Blue)

Part Number: HL-AF-5060H324BS5FS10GC-S1-PLS-R
Number of Units: 30
Case Temperature: >53°C
Ambient Temperature: >50°C

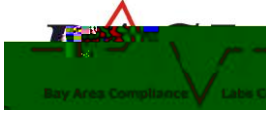

Life Test Drive Current: 20mA

Measurement Current: 20mA

Data Set 6: 85°C, 20mA(Blue)

Part Number: HL-AF-5060H324BS5FS10GC-S1-PLS-R

Number of Units: 30

Case Temperature: >83°C

Ambient Temperature: >80°C

Life Test Drive Current: 20mA

Measurement Current: 20mA

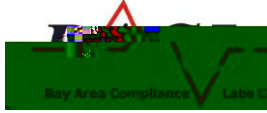

2 Summary of Test Result

Data Set:	Sample Size	Failures Observed:	Test Interval	Test Duration			Reported TM-21 L ₇₀ Lifetime	Reported TM-21 L ₉₀ Lifetime
1	30	0	1000hrs	6000hrs	1.983E-06	1.004	>36000 Hours	>36000 Hours
2	30	0	1000hrs	6000hrs	2.424E-06	1.004	>36000 Hours	>36000 Hours
3	30	0	1000hrs	6000hrs	1.955E-06	1.004	>36000 Hours	>36000 Hours
4	30	0	1000hrs	6000hrs	2.485E-06	1.003	>36000 Hours	>36000 Hours
5	30	0	1000hrs	6000hrs	2.050E-06	1.004	>36000 Hours	>36000 Hours
6	30	0	1000hrs	6000hrs	2.369E-06	1.003	>36000 Hours	>36000 Hours

Average Lumen Maintenance (Percentage of Initial Luminous Flux)

Data Set:	1000hrs	2000hrs	3000hrs	4000hrs	5000hrs	6000hrs
1	100.17%	99.99%	99.81%	99.61%	99.40%	99.18%
2	100.09%	99.87%	99.64%	99.39%	99.14%	98.89%
3	100.16%	99.99%	99.80%	99.60%	99.40%	99.19%
4	100.08%	99.85%	99.59%	99.34%	99.10%	98.85%
5	100.16%	99.95%	99.73%	99.54%	99.33%	99.14%
6	100.09%	99.86%	99.62%	99.38%	99.14%	98.92%

Average Chromaticity Shift

Data Set:	1000hrs	2000hrs	3000hrs	4000hrs	5000hrs	6000hrs
1	0.0002	0.0003	0.0004	0.0006	0.0007	0.0009
2	0.0002	0.0003	0.0005	0.0007	0.0009	0.0010
3	0.0002	0.0003	0.0004	0.0005	0.0006	0.0008
4	0.0002	0.0003	0.0005	0.0006	0.0008	0.0010
5	0.0002	0.0003	0.0004	0.0005	0.0007	0.0008
6	0.0002	0.0003	0.0005	0.0006	0.0008	0.0010



Average Lumen Maintenance and Chromaticity Shift VS. Time

Red

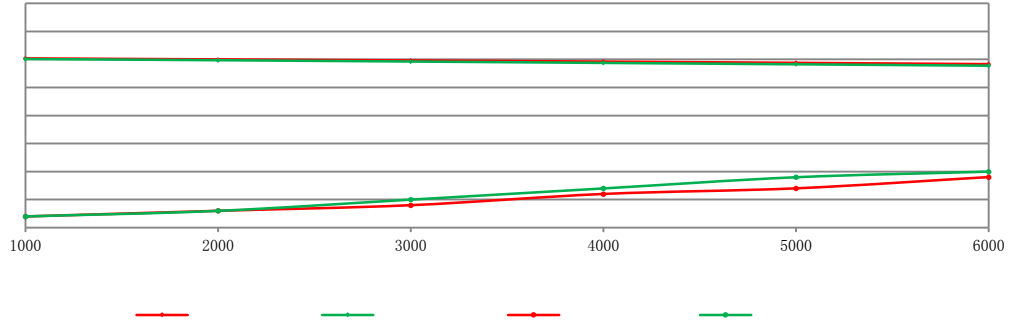

Green

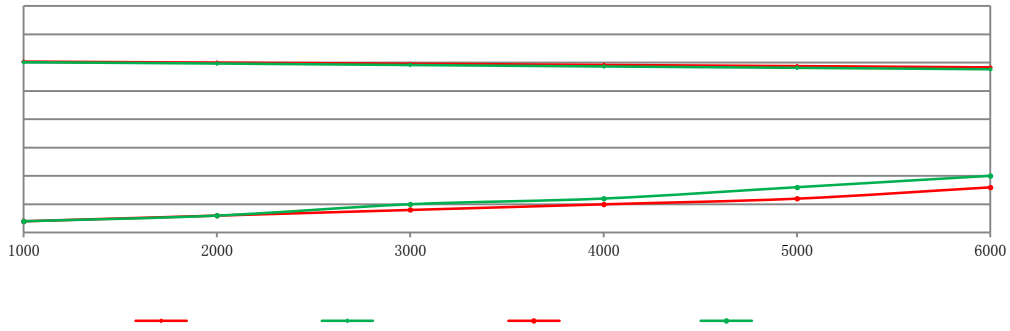

Blue

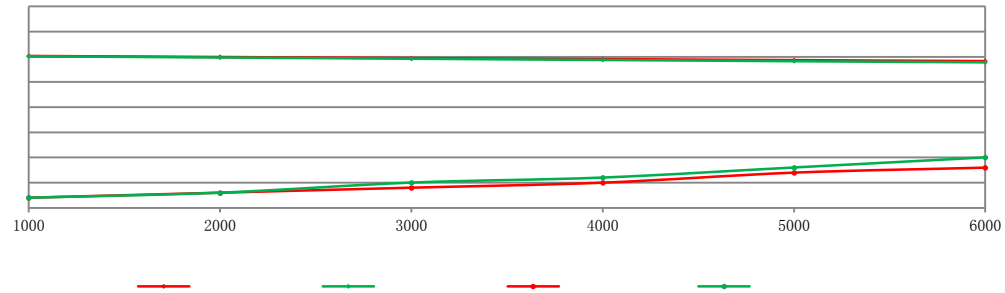

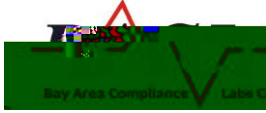

3 Test Data

3.1 Data Set 1, 55°C, 20mA (Lumen Maintenance)

No.	%	Lumen Maintenance (%)					
	0hr(Initial)	1000hrs	2000hrs	3000hrs	4000hrs	5000hrs	6000hrs
1	2.151	100.14	100.09	99.86	99.67	99.54	99.26
2	2.167	99.86	99.72	99.63	99.45	99.22	98.98
3	2.231	100.36	100.18	100.04	99.82	99.64	99.46
4	2.130	100.19	99.95	99.86	99.67	99.48	99.25
5	2.285	100.18	100.09	99.87	99.65	99.47	99.26
6	2.242	99.87	99.64	99.46	99.33	99.06	98.84
7	2.152	99.95	99.63	99.54	99.30	99.12	98.98
8	2.299	100.35	100.17	100.04	99.91	99.61	99.39
9	2.231	100.31	100.09	100.04	99.91	99.69	99.42
10	2.241	100.18	99.96	99.82	99.60	99.42	99.20

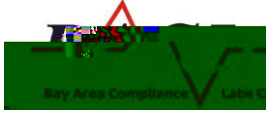

3.2 Data Set 1, 55°C, 20mA (Forward Voltage)

No.	Forward Voltage (V)
-----	---------------------

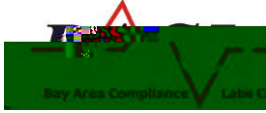

3.3 Data Set 1, 55°C, 20mA (Chromaticity Shift)

No.			Wavelength (nm)	O %					
	0hr(Initial)			1000hrs	2000hrs	3000hrs	4000hrs	5000hrs	6000hrs
1	0.5306	0.5202	622.7	0.0002	0.0004	0.0005	0.0005	0.0006	0.0009
2	0.5297	0.5203	622.4	0.0002	0.0003	0.0005	0.0005	0.0007	0.0009
3	0.5281	0.5206	622.0	0.0003	0.0003	0.0005	0.0007	0.0008	0.0011
4	0.5291	0.5204	622.3	0.0002	0.0004	0.0004	0.0007	0.0009	0.0010
5	0.5256	0.5209	621.4	0.0001	0.0001	0.0002	0.0003	0.0004	0.0005
6	0.5274	0.5207	621.9	0.0003	0.0003	0.0004	0.0005	0.0006	0.0007
7	0.5305	0.5202	622.6	0.0001	0.0002	0.0004	0.0007	0.0009	0.0008
8	0.5245	0.5211	621.1	0.0001	0.0002	0.0004	0.0007	0.0008	0.0009
9	0.5265	0.5208	621.7	0.0002	0.0003	0.0005	0.0007	0.0008	0.0008
10	0.5257	0.5210							

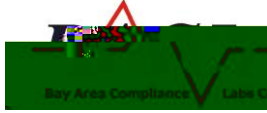

3.4 Data Set 2, 85°C, 20mA (Lumen Maintenance)

No.	%	Lumen Maintenance (%)					
	0hr(Initial)	1000hrs	2000hrs	3000hrs	4000hrs	5000hrs	6000hrs
31	2.207	100.23	100.05	99.95	99.77	99.46	99.05
32	2.229	100.18	99.96	99.78	99.46	99.28	99.01
33	2.169	99.95	99.82	99.63	99.40	99.08	98.85
34	2.243	100.18	99.91	99.69	99.47	99.20	99.06
35	2.126	100.05	99.91	99.58	99.39	99.01	98.82
36	2.107	99.91	99.72	99.57	99.34	99.19	98.91
37	2.149	100.19	99.81	99.63	99.40	99.07	98.88
38	2.145	99.58	99.63	99.53	99.30	99.11	98.83
39	2.176	100.18	100.05	99.82	99.49	99.22	98.99
40	2.260	100.31	99.96	99.65	99.38	99.12	98.76
41	2.175	100.18	99.95	99.77	99.45	99.13	98.85
42	2.192	100.05	99.91	99.73	99.50	99.27	99.04
43	2.161	100.09	99.77	99.63	99.40	99.12	98.98
44	2.159	100.32	99.95	99.68	99.44	99.12	98.89
45	2.145	100.09	99.77	99.53	99.25	99.02	98.74
46	2.153	100.05	99.81	99.54	99.26	99.07	98.79
47	2.096	100.14	99.95	99.86	99.62	99.33	99.14
48	2.146	100.33	99.95	99.67	99.39	99.21	98.88
49	2.115	100.33	100.09	99.86	99.43	99.15	98.87
50	2.143	100.23	100.09	99.77	99.44	99.21	98.97
51	2.195	99.95	99.82	99.54	99.23	99.00	98.72
52	2.124	99.91	99.81	99.48	99.15	98.87	98.73
53	2.122	100.09	99.76	99.53	99.39	99.06	98.73
54	2.201	99.91	99.73	99.55	99.36	99.00	98.73
55	2.128	100.14	99.91	99.58	99.34	99.15	98.87
56	2.097	100.05	99.86	99.52	99.28	99.05	98.76
57	2.133	99.81	99.62	99.44	99.25	99.11	98.92
58	2.107	99.91	99.81	99.43	99.19	99.00	98.77
59	2.161	100.05	99.86	99.68	99.40	99.26	99.12
60	2.119	100.24	99.95	99.72	99.48	99.29	99.06
Avg.	2.156	100.09	99.87	99.64	99.39	99.14	98.89
Med.	2.148	100.09	99.88	99.63	99.39	99.12	98.88
st dev	0.042	0.17	0.12	0.13	0.13	0.12	0.13
Min.	2.096	99.58	99.62	99.43	99.15	98.87	98.72
Max.	2.260	100.33	100.09	99.95	99.77	99.46	99.14

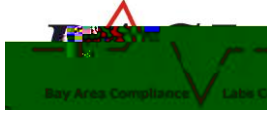

3.5 Data Set 2, 85°C, 20mA (Forward Voltage) 5

No.	Forward Voltage (V)						
	0hr(Initial)	1000hrs	2000hrs	3000hrs	4000hrs	5000hrs	6000hrs
31	2.067	2.074	2.071	2.078	2.076	2.076	2.082
32	2.069	2.076	2.076	2.080	2.080	2.078	2.084
33	2.052	2.059	2.058	2.061	2.061	2.059	2.065
34	2.067	2.075	2.074	2.078	2.078	2.076	2.084
35	2.059	2.064	2.065	2.070	2.067	2.065	2.072
36	2.067	2.074	2.077	2.078	2.078	2.076	2.082
37	2.062	2.069	2.072	2.072	2.070	2.072	2.076
38	2.041	2.046	2.048	2.051	2.051	2.051	2.055
39	2.045	2.050	2.053	2.055	2.055	2.055	2.059
40	2.064	2.070	2.073	2.072	2.072	2.072	2.076
41	2.077	2.076	2.079	2.080	2.078	2.078	2.082
42	2.069	2.071	2.074	2.076	2.074	2.074	2.078
43	2.072	2.074	2.076	2.080	2.078	2.078	2.082
44	2.064	2.067	2.070	2.072	2.070	2.072	2.074
45	2.073	2.074	2.075	2.078	2.076	2.078	2.078
46	2.048	2.050	2.054	2.057	2.053	2.053	2.055
47	2.063	2.067	2.069	2.072	2.070	2.072	2.072
48	2.067	2.072	2.074	2.076	2.074	2.076	2.080
49	2.045	2.051	2.052	2.053	2.053	2.053	2.053
50	2.066	2.071	2.071	2.072	2.072	2.074	2.074
51	2.054	2.055	2.058	2.059	2.059	2.061	2.059
52	2.045	2.051	2.051	2.053	2.051	2.055	2.051
53	2.048	2.052	2.054	2.055	2.053	2.055	2.053
54	2.069	2.072	2.074	2.074	2.074	2.076	2.076
55	2.051	2.056	2.058	2.059	2.059	2.059	2.061
56	2.072	2.072	2.071	2.074	2.074	2.074	2.074
57	2.050	2.055	2.055	2.057	2.057	2.059	2.057

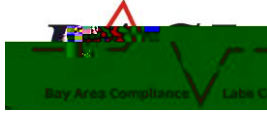

3.6 Data Set 2, 85°C, 20mA (Chromaticity Shift)

No.			Wavelength (nm)	O %					
	0hr(Initial)			1000hrs	2000hrs	3000hrs	4000hrs	5000hrs	6000hrs
31	0.5270	0.5207	621.8	0.0003	0.0004	0.0006	0.0007	0.0008	0.0011
32	0.5255	0.5209	621.4	0.0001	0.0002	0.0005	0.0006	0.0009	0.0013
33	0.5278	0.5206	621.9	0.0002	0.0003	0.0005	0.0008	0.0009	0.0012
34	0.5263	0.5209	621.6	0.0001	0.0004	0.0006	0.0008	0.0009	0.0010
35	0.5296	0.5204	622.4	0.0001	0.0001	0.0003	0.0006	0.0008	0.0009
36	0.5305	0.5202	622.6	0.0001	0.0004	0.0004	0.0006	0.0007	0.0009
37	0.5276	0.5207	621.9	0.0001	0.0004	0.0004	0.0006	0.0009	0.0011
38	0.5295	0.5204	622.4	0.0002	0.0002	0.0004	0.0006	0.0008	0.0009
39	0.5280	0.5206	622.0	0.0002	0.0004	0.0006	0.0007	0.0008	0.0009
40	0.5266	0.5209	621.6	0.0002	0.0005	0.0006	0.0008	0.0010	0.0010
41	0.5244	0.5198	622.3	0.0003	0.0002	0.0004	0.0005	0.0006	0.0007
42	0.5267	0.5195	622.8	0.0001	0.0002	0.0003	0.0006	0.0009	0.0011
43	0.5257	0.5196	622.6	0.0003	0.0004	0.0006	0.0007	0.0010	0.0011
44	0.5273	0.5193	623.0	0.0002	0.0004	0.0006	0.0009	0.0010	0.0013
45	0.5288	0.5191	623.4	0.0002	0.0004	0.0006	0.0008	0.0010	0.0009
46	0.5276	0.5193	623.1	0.0002	0.0003	0.0004	0.0005	0.0008	0.0010
47	0.5274	0.5193	623.1	0.0003	0.0002	0.0004	0.0006	0.0010	0.0011
48	0.5267	0.5194	622.9	0.0001	0.0002	0.0004	0.0006	0.0009	0.0012
49	0.5291	0.5191	623.5	0.0002	0.0004	0.0007	0.0009	0.0009	0.0011
50	0.5271	0.5193	623.0	0.0002	0.0001	0.0004	0.0006	0.0009	0.0011
51	0.5263	0.5195	622.7	0.0003	0.0003	0.0005	0.0007	0.0006	0.0008
52	0.5290	0.5191	623.5	0.0001	0.0002	0.0006	0.0008	0.0008	0.0009
53	0.5279	0.5192	623.2	0.0001	0.0002	0.0005	0.0008	0.0007	0.0009
54	0.5268	0.5194	622.9	0.0001	0.0002	0.0004	0.0007	0.0010	0.0010
55	0.5267	0.5195	622.8	0.0003	0.0004	0.0007	0.0007	0.0009	0.0012
56	0.5292	0.5191	623.5	0.0001	0.0003	0.0004	0.0005	0.0005	0.0009
57	0.5265	0.5194	622.8	0.0001	0.0004	0.0005	0.0007	0.0008	0.0011
58	0.5276	0.5193	623.0	0.0001	0.0003	0.0004	0.0006	0.0006	0.0009
59	0.5269	0.5194	622.9	0.0001	0.0003	0.0006	0.0008	0.0008	0.0011
60	0.5277	0.5193	623.1	0.0003	0.0005	0.0006	0.0009	0.0011	0.0012
Avg.	0.5275	0.5198	622.7	0.0002	0.0003	0.0005	0.0007	0.0009	0.0010
Med.	0.5274	0.5195	622.8	0.0002	0.0003	0.0005	0.0007	0.0009	0.0011
st dev	0.0013	0.0006	0.6	0.0001	0.0001	0.0001	0.0001	0.0001	0.0001
Min.	0.5244	0.5191	621.4	0.0001	0.0001	0.0003	0.0005	0.0005	0.0007
Max.	0.5305	0.5209	623.5	0.0003	0.0005	0.0007	0.0009	0.0011	0.0013

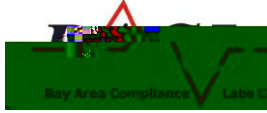

3.7 Data Set 3, 55°C, 20mA (Lumen Maintenance)

No.	Lumen Maintenance (%)						
	% 0hr(Initial)	1000hrs	2000hrs	3000hrs	4000hrs	5000hrs	6000hrs
1	4.723	100.25	100.06	99.83	99.62	99.45	99.30
2	4.785	100.17	99.98	99.75	99.54	99.35	99.14
3	4.890	99.92	99.71	99.57	99.43	99.30	99.04
4	4.774	99.96	99.87	99.77	99.52	99.27	99.12
5	4.813	100.27	100.06	99.81	99.61	99.42	99.27
6	4.927	100.14	100.04	99.86	99.72	99.47	99.23
7	4.802	100.19	100.04	99.90	99.65	99.52	99.38
8	4.943	100.14	99.96	99.84	99.68	99.53	99.31
9	4.761	100.08	99.98	99.79	99.54	99.39	99.14
10	4.718	100.32	100.11	99.94	99.70	99.45	99.22
11	4.829	99.98	99.75	99.57	99.36	99.25	99.05
12	4.711	100.23	100.11	99.92	99.81	99.49	99.30
13	4.714	100.23	100.02	99.92	99.70	99.58	99.30
14	4.815	99.96	99.77	99.65	99.48	99.31	99.11
15	4.928	100.02	99.88	99.76	99.53	99.37	99.19
16	4.676	100.06	99.94	99.76	99.49	99.36	99.08
17	4.895	100.12	99.94	99.75	99.53	99.24	99.02
18	4.766	100.23	100.13	99.98	99.85	99.64	99.45
19	4.829	100.04	99.94	99.69	99.57	99.36	99.21
20	4.730	100.19	99.98	99.85	99.58	99.43	99.18
21	4.736	100.19	100.08	99.98	99.68	99.56	99.32
22	4.777	100.21	100.04	99.85	99.60	99.27	99.02
23	4.912	100.20	100.10	99.80	99.53	99.33	99.19
24	4.748	100.06	99.92	99.66	99.39	99.20	99.09
25	4.816	100.23	99.96	99.77	99.61	99.42	99.11
26	4.806	100.35	100.04	99.73	99.52	99.27	98.96
27	4.912	100.31	100.18	100.04	99.92	99.67	99.41
28	4.922	100.10	99.90	99.63	99.43	99.33	99.13
29	4.726	100.36	100.02	99.77	99.60	99.32	99.05
30	4.710	100.17	100.06	99.83	99.72	99.58	99.28
Avg.	4.803	100.16	99.99	99.80	99.60	99.40	99.19
Med.	4.794	100.18	100.00	99.79	99.59	99.38	99.18
st dev	0.080	0.12	0.11	0.12	0.13	0.12	0.13
Min.	4.676	99.92	99.71	99.57	99.36	99.20	98.96
Max.	4.943	100.36	100.18	100.04	99.92	99.67	99.45

Bay Area

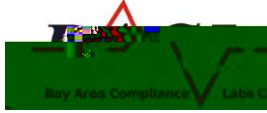

3.9 Data Set 3, 55°C, 20mA (Chromaticity Shift)

No.	0hr(Initial)	Wavelength (nm)	O %						
			1000hrs	2000hrs	3000hrs	4000hrs	5000hrs	6000hrs	
1	0.0529	0.5697	521.9	0.0002	0.0002	0.0004	0.0006	0.0007	0.0009
2	0.0529	0.5686	521.3	0.0002	0.0001	0.0004	0.0005	0.0007	0.0009
3	0.0528	0.5688	521.4	0.0003	0.0001	0.0003	0.0004	0.0005	0.0007
4	0.0536	0.5691	521.8	0.0002	0.0002	0.0003	0.0004	0.0005	0.0009
5	0.0536	0.5692	521.9	0.0002	0.0001	0.0002	0.0005	0.0006	0.0008
6	0.0537	0.5695	522.1	0.0003	0.0001	0.0002	0.0004	0.0004	0.0006
7	0.0527	0.5684	521.1	0.0002	0.0001	0.0002	0.0003	0.0004	0.0006
8	0.0531	0.5688	521.5	0.0001	0.0001	0.0002	0.0003	0.0004	0.0006
9	0.0524	0.5681	520.9	0.0002	0.0001	0.0003	0.0003	0.0004	0.0005
10	0.0527	0.5689	521.4	0.0001	0.0002	0.0004	0.0004	0.0005	0.0007
11	0.0529	0.5684	521.2	0.0001	0.0003	0.0004	0.0004	0.0005	0.0006
12	0.0526	0.5688	521.3	0.0001	0.0004	0.0005	0.0006	0.0007	0.0007
13	0.0526	0.5688	521.3	0.0003	0.0003	0.0004	0.0005	0.0006	0.0007
14	0.0543	0.5696	522.3	0.0002	0.0004	0.0004	0.0006	0.0007	0.0007
15	0.0540	0.5693	522.1	0.0002	0.0003	0.0004	0.0004	0.0006	0.0007
16	0.0531	0.5689	521.5	0.0002	0.0005	0.0005	0.0006	0.0008	0.0009
17	0.0527	0.5686	521.2	0.0001	0.0002	0.0004	0.0004	0.0005	0.0008
18	0.0532	0.5693	521.8	0.0002	0.0002	0.0005	0.0004	0.0006	0.0006
19	0.0531	0.5689	521.5	0.0000	0.0002	0.0005	0.0004	0.0006	0.0007
20	0.0530	0.5699	522.0	0.0001	0.0003	0.0004	0.0005	0.0007	0.0008
21	0.0539	0.5697	522.3	0.0001	0.0002	0.0005	0.0005	0.0006	0.0008
22	0.0524	0.5680	520.8	0.0001	0.0003	0.0004	0.0004	0.0007	0.0009
23	0.0529	0.5687	521.4	0.0001	0.0003	0.0004	0.0005	0.0008	0.0010
24	0.0537	0.5694	522.0	0.0003	0.0005	0.0005	0.0006	0.0009	0.0010
25	0.0528	0.5684	521.2	0.0001	0.0003	0.0004	0.0006	0.0008	0.0008
26	0.0526	0.5682	521.0	0.0001	0.0004	0.0003	0.0004	0.0008	0.0010
27	0.0528	0.5683	521.1	0.0001	0.0002	0.0003	0.0006	0.0006	0.0009
28	0.0533	0.5690	521.7	0.0001	0.0002	0.0004	0.0006	0.0007	0.0010
29	0.0527	0.5698	521.9	0.0001	0.0002	0.0003	0.0005	0.0008	0.0009
30	0.0527	0.5686	521.2	0.0002	0.0002	0.0003	0.0006	0.0007	0.0009
Avg.	0.0531	0.5689	521.5	0.0002	0.0003	0.0004	0.0005	0.0006	0.0008
Med.	0.0529	0.5689	521.5	0.0002	0.0002	0.0004	0.0005	0.0006	0.0008
st dev	0.0005	0.0005	0.4	0.0001	0.0001	0.0001	0.0001	0.0001	0.0001
Min.	0.0524	0.5680	520.8	0.0000	0.0001	0.0002	0.0003	0.0004	0.0005
Max.	0.0543	0.5699	522.3	0.0003	0.0005	0.0005	0.0006	0.0009	0.0010

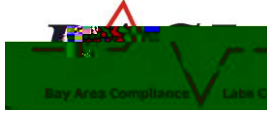

3.10 Data Set 4, 85°C, 20mA (Lumen Maintenance)

No.	%	Lumen Maintenance (%)					
	0hr(Initial)	1000hrs	2000hrs	3000hrs	4000hrs	5000hrs	6000hrs
31	4.909	100.12	99.96	99.74	99.51	99.19	99.02
32	4.643	100.15	99.91	99.68	99.42	99.16	98.88
33	4.792	99.94	99.73	99.48	99.25	99.10	98.79
34	4.892	99.92	99.61	99.47	99.28	99.06	98.88
35	4.926	100.18	99.94	99.68	99.33	99.17	99.01
36	4.644	100.22	99.96	99.74	99.46	99.25	99.01
37	4.654	100.34	100.17	99.91	99.55	99.29	98.97
38	4.866	100.23	99.96	99.61	99.28	99.16	98.87
39	4.809	100.12	99.81	99.50	99.25	98.94	98.71
40	4.768	100.21	99.98	99.77	99.43	99.27	98.91
41	4.848	100.12	99.83	99.65	99.40	99.05	98.72
42	4.892	100.33	100.12	99.73	99.45	99.24	98.83
43	4.662	100.19	99.91	99.61	99.25	99.10	98.76
44	4.840	99.94	99.63	99.46	99.21	99.09	98.74
45	4.701	100.23	100.04	99.77	99.55	99.30	98.96
46	4.814	100.12	99.85	99.54	99.31	99.04	98.86
47	4.694	100.23	100.09	99.79	99.42	99.08	98.85
48	4.726	100.02	99.72	99.53	99.22	98.92	98.67
49	4.851	99.98	99.79	99.48	99.24	98.82	98.62
50	4.698	100.04	99.81	99.43	99.23	98.96	98.74
51	4.887	100.04	99.84	99.59	99.28	99.02	98.69
52	4.879	99.94	99.61	99.43	99.24	99.00	98.79
53	4.847	99.83	99.63	99.36	99.24	98.91	98.60
54	4.900	100.06	99.73	99.51	99.24	99.12	98.88
55	4.833	99.88	99.75	99.40	99.30	99.01	98.84
56	4.763	100.08	99.92	99.75	99.60	99.33	99.12
57	4.767	100.02	99.85	99.69	99.33	99.20	99.06
58	4.742	99.96	99.75	99.58	99.43	99.18	98.99
59	4.675	99.85	99.72	99.44	99.29	99.06	98.80
60	4.885	100.02	99.84	99.53	99.28	99.08	98.85
Avg.	4.794	100.08	99.85	99.59	99.34	99.10	98.85
Med.	4.812	100.07	99.84	99.58	99.30	99.10	98.85
st dev	0.091	0.14	0.15	0.14	0.11	0.13	0.13
Min.	4.643	99.83	99.61	99.36	99.21	98.82	98.60
Max.	4.926	100.34	100.17	99.91	99.60	99.33	99.12

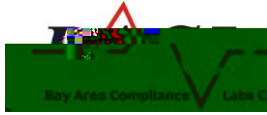

3.11 Data Set 4, 85°C, 20mA (Forward Voltage)

No.	Forward Voltage (V)						
	0hr(Initial)	1000hrs	2000hrs	3000hrs	4000hrs	5000hrs	6000hrs
31	3.106	3.111	3.114	3.122	3.124	3.124	3.121
32	3.109	3.113	3.117	3.125	3.127	3.125	3.124
33	3.097	3.101	3.105	3.111	3.113	3.114	3.108
34	3.112	3.116	3.122	3.128	3.128	3.126	3.126
35	3.115	3.122	3.126	3.132	3.131	3.132	3.128
36	3.106	3.115	3.115	3.124	3.119	3.123	3.119
37	3.096	3.104	3.105	3.114	3.109	3.114	3.107
38	3.096	3.107	3.103	3.111	3.106	3.110	3.107
39	3.103	3.111	3.111	3.118	3.114	3.118	3.116
40	3.101	3.110	3.130	3.118	3.116	3.116	3.117
41	3.120	3.131	3.130	3.139	3.135	3.137	3.134
42	3.110	3.121	3.120	3.126	3.124	3.125	3.125
43	3.107	3.116	3.115	3.120	3.118	3.122	3.120
44	3.111	3.124	3.120	3.128	3.123	3.127	3.124
45	3.103	3.118	3.110	3.119	3.116	3.120	3.119
46	3.097	3.110	3.105	3.114	3.116	3.113	3.110
47	3.099	3.116	3.109	3.119	3.117	3.118	3.117
48	3.113	3.127	3.123	3.130	3.126	3.128	3.127
49	3.100	3.113	3.107	3.115	3.113	3.115	3.110
50	3.107	3.121	3.117	3.123	3.121	3.123	3.120
51	3.100	3.107	3.110	3.117	3.115	3.117	3.114
52	3.099	3.108	3.109	3.117	3.114	3.114	3.113
53	3.101	3.109	3.109	3.117	3.113	3.113	3.115
54	3.113	3.120	3.121	3.130	3.127	3.126	3.126

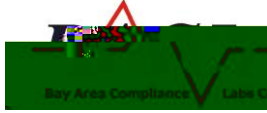

3.12Data Set 4, 85°C, 20mA (Chromaticity Shift)

No.			Wavelength (nm)	O %					
	0hr(Initial)			1000hrs	2000hrs	3000hrs	4000hrs	5000hrs	6000hrs
31	0.0528	0.5686	521.2	0.0002	0.0003	0.0005	0.0005	0.0009	0.0010
32	0.0532	0.5688	521.5	0.0002	0.0004	0.0006	0.0006	0.0009	0.0011
33	0.0527	0.5682	521.0	0.0001	0.0003	0.0004	0.0007	0.0008	0.0010
34	0.0531	0.5688	521.5	0.0002	0.0004	0.0006	0.0006	0.0009	0.0011
35	0.0526	0.5683	521.1	0.0002	0.0003	0.0005	0.0007	0.0005	0.0010
36	0.0527	0.5695	521.7	0.0003	0.0004	0.0007	0.0006	0.0009	0.0012
37	0.0527	0.5685	521.2	0.0003	0.0004	0.0006	0.0006	0.0009	0.0011
38	0.0530	0.5687	521.4	0.0003	0.0003	0.0004	0.0008	0.0008	0.0009
39	0.0530	0.5684	521.2	0.0002	0.0003	0.0005	0.0007	0.0009	0.0010
40	0.0532	0.5689	521.6	0.0002	0.0004	0.0004	0.0007	0.0008	0.0009
41	0.0532	0.5692	521.8	0.0003	0.0003	0.0004	0.0007	0.0007	0.0008
42	0.0528	0.5684	521.2	0.0004	0.0004	0.0005	0.0006	0.0009	0.0010
43	0.0530	0.5687	521.4	0.0003	0.0004	0.0005	0.0006	0.0009	0.0009
44	0.0532	0.5688	521.5	0.0003	0.0004	0.0005	0.0006	0.0008	0.0011
45	0.0532	0.5698	522.1	0.0003	0.0004	0.0006	0.0005	0.0009	0.0010
46	0.0533	0.5686	521.5	0.0003	0.0005	0.0006	0.0008	0.0009	0.0010
47	0.0526	0.5685	521.1	0.0002	0.0004	0.0005	0.0007	0.0009	0.0010
48	0.0533	0.5692	521.8	0.0001	0.0004	0.0006	0.0006	0.0009	0.0011
49	0.0531	0.5687	521.4	0.0001	0.0002	0.0005	0.0005	0.0008	0.0009
50	0.0525	0.5687	521.2	0.0002	0.0002	0.0004	0.0006	0.0008	0.0009
51	0.0533	0.5688	521.6	0.0003	0.0001	0.0004	0.0004	0.0007	0.0009
52	0.0527	0.5686	521.2	0.0002	0.0001	0.0004	0.0005	0.0008	0.0010
53	0.0522	0.5679	520.7	0.0002	0.0001	0.0004	0.0006	0.0008	0.0010
54	0.0527	0.5685	521.2	0.0002	0.0003	0.0005	0.0007	0.0010	0.0011
55	0.0534	0.5688	521.6	0.0001	0.0003	0.0006	0.0007	0.0010	0.0011
56	0.0526	0.5682	521.0	0.0001	0.0002	0.0006	0.0006	0.0009	0.0011
57	0.0526	0.5682	521.0	0.0001	0.0003	0.0007	0.0007	0.0009	0.0011
58	0.0538	0.5697	522.2	0.0001	0.0002	0.0005	0.0007	0.0009	0.0011
59	0.0530	0.5690	521.6	0.0002	0.0002	0.0005	0.0006	0.0009	0.0010
60	0.0524	0.5683	520.9	0.0002	0.0002	0.0004	0.0006	0.0008	0.0009
Avg.	0.0529	0.5687	521.4	0.0002	0.0003	0.0005	0.0006	0.0008	0.0010
Med.	0.0530	0.5687	521.4	0.0002	0.0003	0.0005	0.0006	0.0009	0.0010
st dev	0.0004	0.0004	0.3	0.0001	0.0001	0.0001	0.0001	0.0001	0.0001
Min.	0.0522	0.5679	520.7	0.0001	0.0001	0.0004	0.0004	0.0005	0.0008
Max.	0.0538	0.5698	522.2	0.0004	0.0005	0.0007	0.0008	0.0010	0.0012

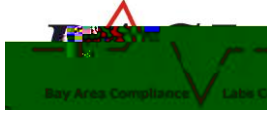

3.13 Data Set 5, 55°C, 20mA (Lumen Maintenance)

No.	Lumen Maintenance (%)						
	% 0hr(Initial)	1000hrs	2000hrs	3000hrs	4000hrs	5000hrs	6000hrs
1	1.133	100.26	100.18	99.91	99.74	99.47	99.29
2	1.120	100.27	100.09	99.73	99.46	99.20	99.02
3	1.196	100.17	99.92	99.75	99.58	99.41	99.16
4	1.131	100.18	99.91	99.73	99.56	99.29	98.94
5	1.165	100.26	100.09	99.74	99.48	99.40	99.23
6	1.161	100.17	99.91	99.74	99.48	99.22	99.14
7	1.123	100.09	99.91	99.64	99.47	99.20	99.02
8	1.148	100.09	99.83	99.65	99.39	99.13	98.95
9	1.182	100.17	99.92	99.75	99.58	99.32	99.07
10	1.134	100.09	99.91	99.65	99.47	99.29	99.12
11	1.160	100.09	99.83	99.66	99.57	99.31	99.14
12	1.124	100.27	100.09	99.73	99.56	99.47	99.29
13	1.130	100.27	100.09	99.73	99.56	99.38	99.12
14	1.129	100.27	99.91	99.82	99.65	99.47	99.29
15	1.167	100.26	100.09	99.83	99.66	99.40	99.06
16	1.112	100.09	99.91	99.82	99.55	99.46	99.28
17	1.208	100.25	99.92	99.67	99.50	99.25	99.09
18	1.143	100.09	99.91	99.74	99.48	99.39	99.13
19	1.177	100.17	99.92	99.83	99.58	99.41	99.32
20	1.147	100.26	99.91	99.65	99.48	99.30	99.13
21	1.119	100.18	99.91	99.64	99.55	99.37	99.11
22	1.158	99.91	99.74	99.57	99.31	99.14	98.88
23	1.130	100.18	99.91	99.73	99.47	99.20	99.12
24	1.133	100.09	99.91	99.74	99.65	99.29	99.21
25	1.178	100.17	100.08	99.83	99.66	99.49	99.32
26	1.174	99.91	99.74	99.57	99.40	99.15	98.98
27	1.180	100.08	99.92	99.75	99.49	99.24	99.07
28	1.124	100.09	99.91	99.82	99.56	99.38	99.29
29	1.131	100.09	99.91	99.82	99.65	99.47	99.29
30	1.146	100.26	100.09	99.74	99.65	99.30	99.04
Avg.	1.149	100.16	99.95	99.73	99.54	99.33	99.14
Med.	1.145	100.17	99.91	99.74	99.55	99.32	99.12
st dev	0.025	0.10	0.11	0.08	0.09	0.11	0.12
Min.	1.112	99.91	99.74	99.57	99.31	99.13	98.88
Max.	1.208	100.27	100.18	99.91	99.74	99.49	99.32

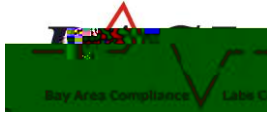

3.14 Data Set 5, 55°C, 20mA (Forward Voltage)

No.	Forward Voltage (V)						
	0hr(Initial)	1000hrs	2000hrs	3000hrs	4000hrs	5000hrs	6000hrs
1	3.048	3.051	3.055	3.049	3.054	3.048	3.054
2	3.045	3.050	3.055	3.049	3.052	3.049	3.053
3	3.043	3.046	3.052	3.048	3.050	3.046	3.048
4	3.053	3.054	3.057	3.055	3.054	3.053	3.055
5	3.033	3.033	3.036	3.035	3.033	3.032	3.034
6	3.023	3.023	3.027	3.027	3.022	3.024	3.027
7	3.044	3.042	3.046	3.046	3.043	3.043	3.045
8	3.048	3.046	3.049	3.051	3.047	3.047	3.049
9	3.016	3.014	3.020	3.019	3.015	3.016	3.018
10	3.044	3.042	3.045	3.046	3.041	3.043	3.045
11	3.017	3.015	3.018	3.018	3.019	3.016	3.017
12	3.027	3.026	3.030	3.028	3.029	3.027	3.028
13	3.050	3.048	3.051	3.048	3.048	3.048	3.050
14	3.051	3.048	3.052	3.051	3.050	3.048	3.050
15	3.027	3.025	3.029	3.029	3.027	3.026	3.028
16	3.045	3.045	3.050	3.051	3.046	3.044	3.047
17	3.033	3.035	3.034	3.037	3.032	3.033	3.033

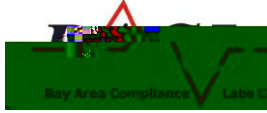

3.15 Data Set 5, 55°C, 20mA (Chromaticity Shift)

No.			Wavelength (nm)	O %					
	Ohr(Initial)			1000hrs	2000hrs	3000hrs	4000hrs	5000hrs	6000hrs
1	0.1695	0.1321	465.3	0.0002	0.0002	0.0004	0.0007	0.0008	0.0011
2	0.1715	0.1280	464.8	0.0002	0.0004	0.0003	0.0004	0.0006	0.0008
3	0.1690	0.1328	465.5	0.0001	0.0003	0.0004	0.0004	0.0005	0.0006
4	0.1693	0.1329	465.4	0.0001	0.0003	0.0003	0.0005	0.0005	0.0007
5	0.1688	0.1332	465.5	0.0001	0.0003	0.0004	0.0005	0.0005	0.0006
6	0.1691	0.1326	465.5	0.0001	0.0002	0.0003	0.0005	0.0006	0.0007
7	0.1689	0.1335	465.5	0.0001	0.0003	0.0003	0.0005	0.0008	0.0010
8	0.1718	0.1281	464.8	0.0002	0.0002	0.0003	0.0006	0.0007	0.0009
9	0.1686	0.1331	465.6	0.0002	0.0002	0.0003	0.0005	0.0006	0.0008
10	0.1719	0.1283	464.8	0.0002	0.0004	0.0004	0.0007	0.0008	0.0008
11	0.1697	0.1315	465.3	0.0001	0.0003	0.0004	0.0005	0.0007	0.0009
12	0.1709	0.1308	465.0	0.0002	0.0005	0.0006	0.0009	0.0009	0.0012
13	0.1720	0.1289	464.8	0.0001	0.0004	0.0006	0.0007	0.0009	0.0011
14	0.1697	0.1327	465.3	0.0002	0.0004	0.0004	0.0007	0.0007	0.0009
15	0.1686	0.1331	465.6	0.0001	0.0002	0.0002	0.0005	0.0005	0.0006
16	0.1718	0.1288	464.8	0.0001	0.0001	0.0002	0.0004	0.0006	0.0007
17	0.1706	0.1296	465.1	0.0001	0.0002	0.0002	0.0004	0.0005	0.0006
18	0.1683	0.1348	465.7	0.0002	0.0004	0.0005	0.0005	0.0006	0.0007
19	0.1687	0.1332	465.5	0.0001	0.0002	0.0005	0.0004	0.0006	0.0007
20	0.1691	0.1345	465.5	0.0001	0.0003	0.0004	0.0006	0.0009	0.0011
21	0.1715	0.1294	464.9	0.0002	0.0002	0.0003	0.0004	0.0006	0.0007
22	0.1695	0.1314	465.3	0.0002	0.0005	0.0004	0.0005	0.0007	0.0009
23	0.1723	0.1267	464.6	0.0000	0.0003	0.0004	0.0006	0.0008	0.0009
24	0.1718	0.1294	464.8	0.0003	0.0002	0.0003	0.0004	0.0006	0.0006
25	0.1709	0.1293	465.0	0.0001	0.0001	0.0003	0.0006	0.0006	0.0007
26	0.1693	0.1320	465.4	0.0001	0.0002	0.0004	0.0004	0.0005	0.0008
27	0.1698	0.1314	465.3	0.0002	0.0002	0.0004	0.0004	0.0005	0.0007
28	0.1721	0.1275	464.7	0.0003	0.0004	0.0004	0.0006	0.0006	0.0008
29	0.1696	0.1329	465.3	0.0002	0.0004	0.0004	0.0005	0.0007	0.0009
30	0.1713	0.1301	464.9	0.0002	0.0002	0.0006	0.0005	0.0007	0.0009
Avg.	0.1702	0.1311	465.2	0.0002	0.0003	0.0004	0.0005	0.0007	0.0008
Med.	0.1697	0.1315	465.3	0.0002	0.0003	0.0004	0.0005	0.0006	0.0008
st dev	0.0013	0.0022	0.3	0.0001	0.0001	0.0001	0.0001	0.0001	0.0002
Min.	0.1683	0.1267	464.6	0.0000	0.0001	0.0002	0.0004	0.0005	0.0006
Max.	0.1723	0.1348	465.7	0.0003	0.0005	0.0006	0.0009	0.0009	0.0012

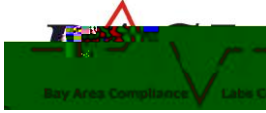

3.16 Data Set 6, 85°C, 20mA (Lumen Maintenance)

No.	% 0hr(Initial)	1000hrs	Lumen Maintenance (%)
-----	-------------------	---------	-----------------------

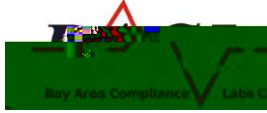

3.17 Data Set 6, 85°C, 20mA (Forward Voltage)

No.	Forward Voltage (V)						
	0hr(Initial)	1000hrs	2000hrs	3000hrs	4000hrs	5000hrs	6000hrs
31	3.044	3.051	3.044	3.049	3.043	3.048	3.049
32	3.046	3.054	3.046	3.053	3.046	3.052	3.052
33	3.012	3.017	3.012	3.017	3.011	3.017	3.016
34	3.045	3.049	3.044	3.049	3.045	3.051	3.051
35	3.046	3.051	3.046	3.051	3.046	3.050	3.051
36	3.049	3.054	3.046	3.052	3.047	3.052	3.053
37	3.040	3.045	3.036	3.043	3.040	3.043	3.043
38	3.035	3.041	3.033	3.036	3.035	3.038	3.039
39	3.038	3.044	3.036	3.042	3.038	3.044	3.042
40	3.023	3.030	3.020	3.027	3.023	3.029	3.028
41	3.030	3.036	3.029	3.035	3.031	3.035	3.033
42	3.029	3.034	3.027	3.033	3.029	3.033	3.031
43	3.044	3.051	3.043	3.046	3.042	3.047	3.045
44	3.022	3.030	3.020	3.026	3.022	3.026	3.024
45	3.051	3.058	3.049	3.051	3.050	3.054	3.052
46	3.045	3.052	3.040	3.046	3.045	3.046	3.048
47	3.042	3.047	3.037	3.041	3.041	3.043	3.041
48	3.044	3.048	3.039	3.044	3.043	3.046	3.044
49	3.046	3.052	3.041	3.048	3.046	3.048	3.050
50	3.036	3.043	3.033	3.040	3.036	3.037	3.041
51	3.034	3.040	3.029	3.032	3.031	3.033	3.033
52	3.039	3.049	3.040	3.043	3.041	3.043	3.043
53	3.016	3.022	3.015	3.018	3.016	3.017	3.016
54	3.045	3.052	3.041	3.046	3.044	3.046	3.045



3.18 Data Set 6, 85°C, 20mA (Chromaticity Shift)

No.			Wavelength (nm)	O %					
	0hr(Initial)			1000hrs	2000hrs	3000hrs	4000hrs	5000hrs	6000hrs
31	0.1702	0.1305	465.2	0.0001	0.0002	0.0003	0.0006	0.0007	0.0009
32	0.1696	0.1328	465.3	0.0003	0.0005	0.0007	0.0009	0.0010	0.0011
33	0.1684	0.1333	465.6	0.0001	0.0003	0.0004	0.0007	0.0009	0.0009
34	0.1713	0.1287	464.9	0.0002	0.0003	0.0005	0.0007	0.0009	0.0011
35	0.1708	0.1304	465.1	0.0003	0.0005	0.0004	0.0005	0.0008	0.0009
36	0.1696	0.1334	465.3	0.0002	0.0004	0.0005	0.0008	0.0009	0.0011
37	0.1714	0.1308	464.9	0.0001	0.0001	0.0003	0.0003	0.0006	0.0007
38	0.1692	0.1328	465.4	0.0002	0.0004	0.0004	0.0006	0.0006	0.0007
39	0.1701	0.1322	465.2	0.0003	0.0005	0.0006	0.0006	0.0007	0.0008
40	0.1693	0.1319	465.4	0.0002	0.0004	0.0005	0.0005	0.0008	0.0008
41	0.1717	0.1287	464.8	0.0001	0.0002	0.0004	0.0007	0.0009	0.0010
42	0.1683	0.1337	465.6	0.0001	0.0003	0.0005	0.0006	0.0008	0.0010
43	0.1702	0.1312	465.2	0.0003	0.0005	0.0007	0.0008	0.0009	0.0011
44	0.1682	0.1338	465.7	0.0002	0.0004	0.0006	0.0008	0.0010	0.0011
45	0.1698	0.1316	465.3	0.0002	0.0004	0.0005	0.0005	0.0008	0.0011
46	0.1715	0.1290	464.9	0.0002	0.0003	0.0006	0.0006	0.0008	0.0010
47	0.1717	0.1290	464.8	0.0002	0.0004	0.0006	0.0007	0.0007	0.0009
48	0.1716	0.1300	464.9	0.0003	0.0003	0.0004	0.0007	0.0007	0.0009
49	0.1691	0.1327	465.4	0.0002	0.0002	0.0004	0.0005	0.0007	0.0009
50	0.1717	0.1295	464.8	0.0003	0.0002	0.0004	0.0005	0.0006	0.0009
51	0.1724	0.1273	464.6	0.0002	0.0005	0.0004	0.0005	0.0005	0.0009
52	0.1689	0.1336	465.5	0.0001	0.0004	0.0005	0.0005	0.0008	0.0011
53	0.1701	0.1312	465.2	0.0003	0.0004	0.0005	0.0007	0.0007	0.0009
54	0.1711	0.1292	464.9	0.0002	0.0004	0.0006	0.0009	0.0009	0.0011
55	0.1701	0.1315	465.2	0.0002	0.0004	0.0006	0.0009	0.0011	0.0012
56		0.1315	465.3			0.0004	0.0006	0.0009	0.0011
57		0.1315	465.3			0.0004	0.0006	0.0007	0.0009
58		0.1343	465.7				0.0004	0.0005	0.0006
59		0.1295	464.9			0.0004	0.0005	0.0007	0.0010
							0.0007	0.0010	0.0009
							0.0006	0.0008	0.0010
							0.0006	0.0008	0.0009
	st dev	0.0019	0.3		0.0001	0.0001	0.0001	0.0002	0.0001
	0.1681	0.1273	464.6		0.0001				

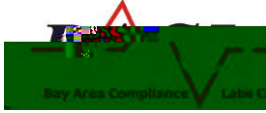

4 DUT Photo

4.1 Mechanical Dimensions

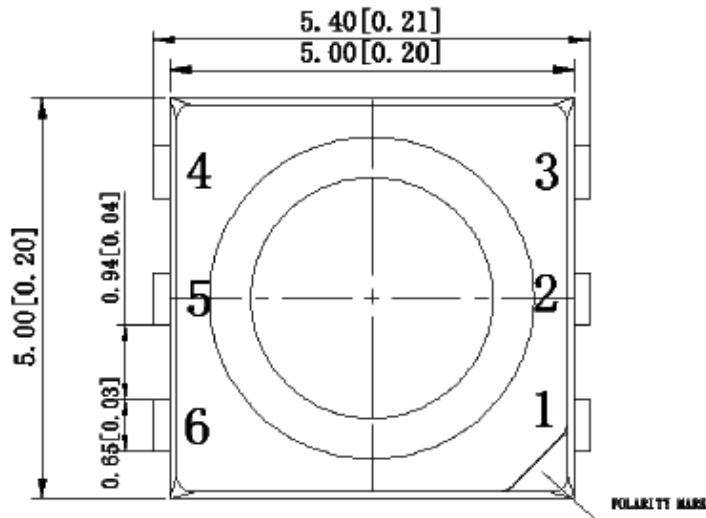

All dimensions are in millimeter

4.2 DUT Photo

Red

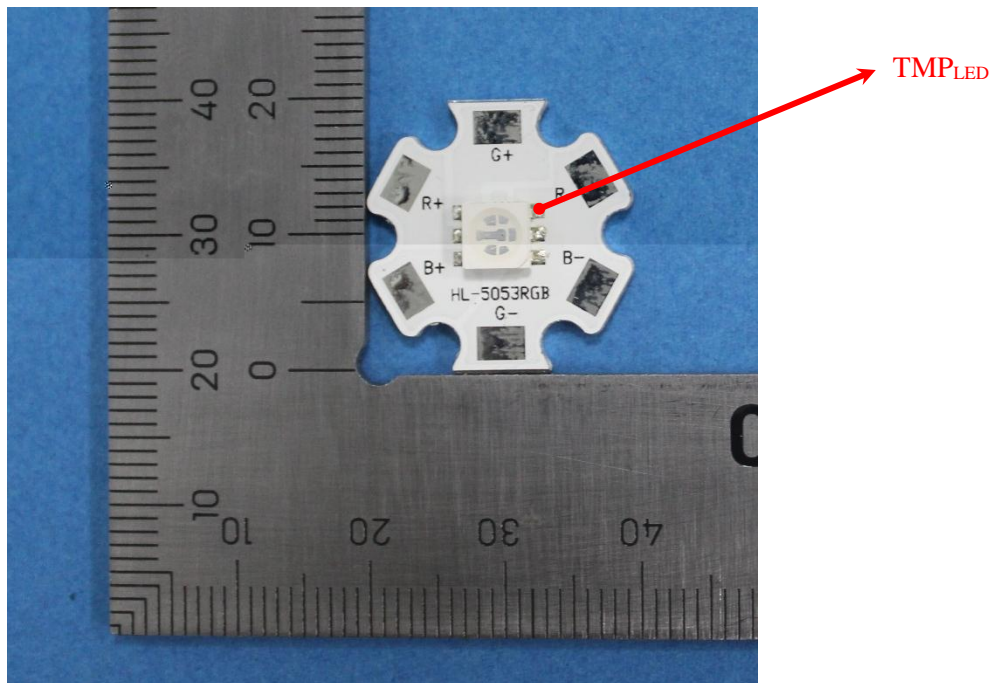

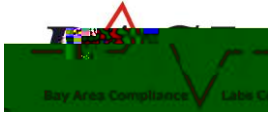

Green

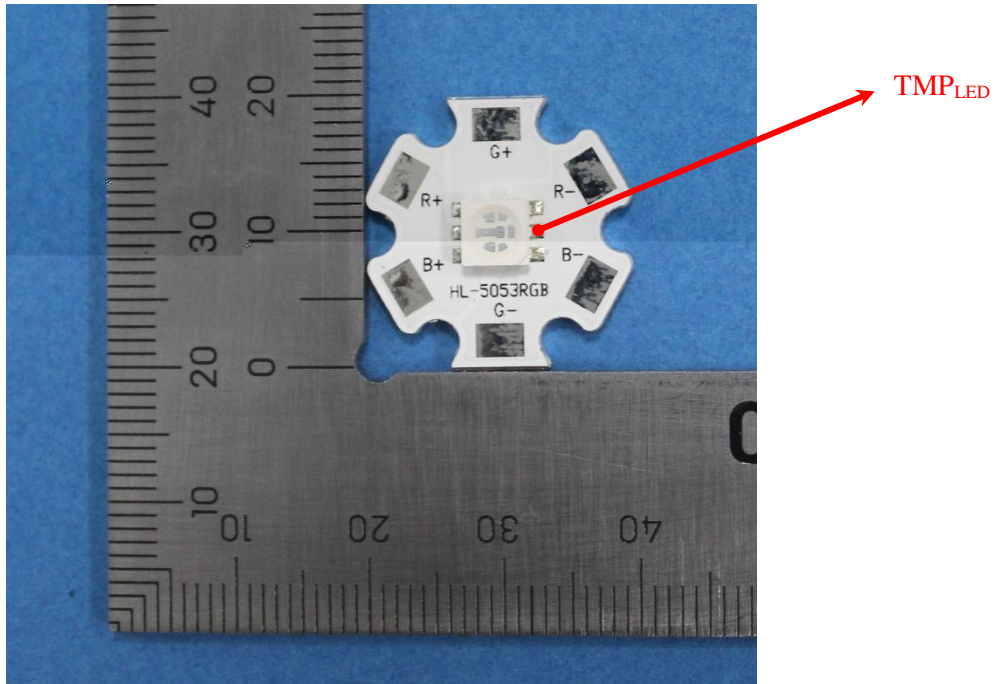

Blue

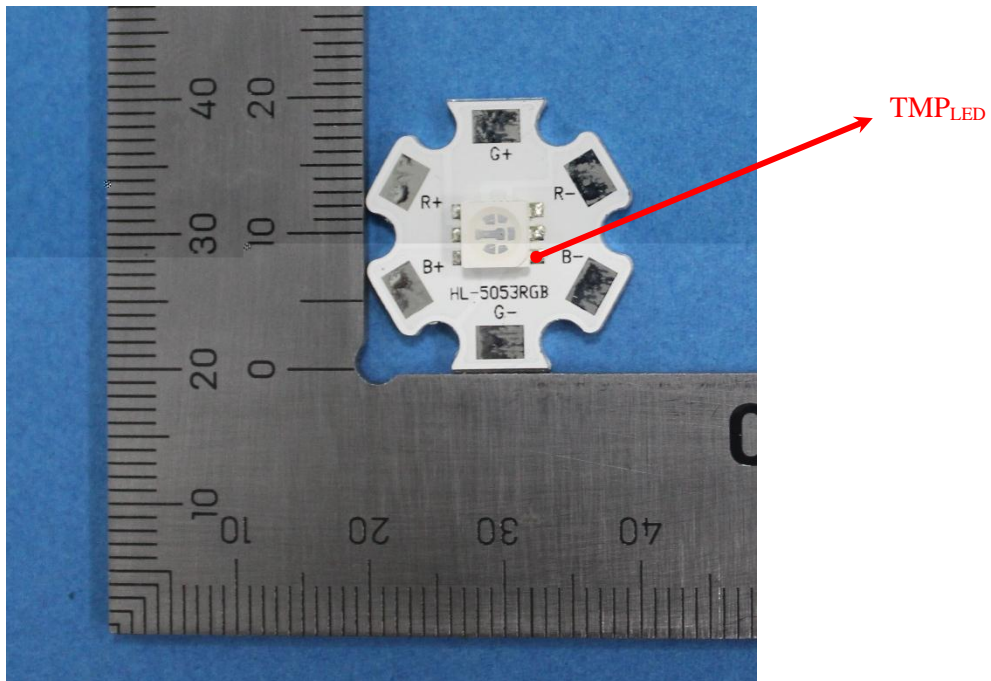

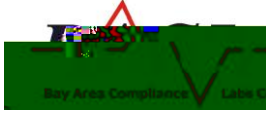

Bay Area Compliance Laboratories Corp. (Dongguan)

No.12, Pulong East 1st Road, Tangxia Town,
Dongguan, Guangdong, China.

Directions

*****END OF REPORT*****